

PSE CONSULTING ENGINEERS INC.

STRUCTURAL ENGINEERING CALCULATIONS

PROJECT: Aluminum and glass infill guard rail design

PROJECT LOCATION: California and Texas

PSE PROJECT NUMBER: EGlass 217-2

DATE: September 4, 2020

BY: Adel Elfayoumy, Ph.D., P.E.

BY: Nabil Taha, Ph.D., P.E.



EXPIRES: 06-30-21

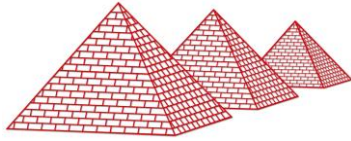
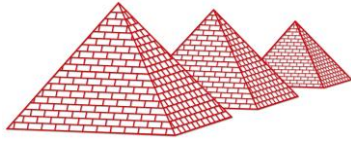

Table of Contents:

Subject:	Page:
1- References / Software:	10-19
2- Design Criteria:	100-199
3- Guard Rail Analysis & Design:	1,000-1,999
4- Deck and Fascia Mount Analysis & Design:	2,000-2,999



References:

1- Literature:

- a. 2019 California Building Code, based on 2018 International Building Code (IBC)
- b. 2019 California Residential Code, based on 2018 International Residential Code (IBC)
- c. 2015 International Building Code with local amendments
- d. 2015 International Residential Code with local amendments
- e. AISC Design Guide 27: Structural Stainless Steel.
- f. National Design Specifications for Wood Construction, 2015 Edition
- g. Building Code Requirements for Structural Concrete (ACI318-14)

2- Software:

- a. RISA 3D Version 15.0.2
RISA Technologies,
26212 Dimension Dr. Suite 200

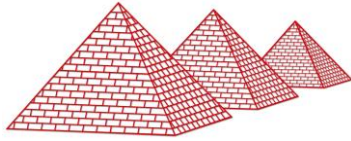

Design Criteria:

- 1- Location: California and Texas
- 2- Live Load on Handrail & guards:
- a. Uniform Distributed load 50 p/f
 - b. Single Concentrated load 200 lbs
 - c. 50 psf on infill
- 3- Wind:
- | | |
|------------------|---------------------|
| Basic wind speed | 110 mph (3 s. gust) |
| Exposure | C |

**Other criteria assumed as stated in design calculations.



PROJECT NO. Eglass 217-2 SHEET _____ OF _____
PROJECT NAME _____ DESIGNED BY AF DATE _____
SUBJECT _____ CHECKED BY _____ DATE _____

Conclusion 117

- Glass w/ Top & bottom rail:

Material = Alu. 6061-T6

Post: $2 \frac{3}{8}'' \times 2 \frac{3}{8}'' \times 0.125''$ (42" height, 4' apart)

Top rail: $2 \frac{3}{8}'' \times 1 \frac{1}{2}'' \times 0.125''$

Bottom rail: $1 \frac{1}{4}'' \times 1 \frac{1}{4}'' \times 0.125''$

Glass = Fully Tempered $\frac{1}{4}''$ or $\frac{3}{8}''$ thick

- Glass w/ clip

Post: $2 \frac{3}{8}'' \times 2 \frac{3}{8}'' \times 0.125''$

Glass = Fully tempered, $\frac{3}{8}''$ thick



PROJECT NO. Eglars 21A-2 SHEET _____ OF _____
PROJECT NAME _____ DESIGNED BY AF DATE _____
SUBJECT _____ CHECKED BY _____ DATE _____

Conclusion (2/7)

* For square post (square base plate)

Base plate, Alu. Alloy 384 (ADC12), $F_y = 24 \text{ KSI}$

$(4\frac{1}{2} * 4\frac{1}{2} * 3/8)$

Anchors

To Concrete

[4 - $\frac{3}{8}$ " ϕ Red head w/min 4" Embed,
Edge distance $3\frac{1}{2}$ " , $f_c \geq 3000 \text{ psi}$]

To wood

[4 - $\frac{3}{8}$ " ϕ lag screw w/min 6" Embed]

OR

[4 - $\frac{3}{8}$ " ϕ thru-bolt]



PROJECT NO: Eg/288 217-2 SHEET _____ OF _____
PROJECT NAME _____ DESIGNED BY AF DATE _____
SUBJECT _____ CHECKED BY _____ DATE _____

Conclusion 3/7

135° post and base plate

- post = Alu. 6061-T6,
 $t = 0.125"$

- Base plate = 0.39" thick
(As shown)

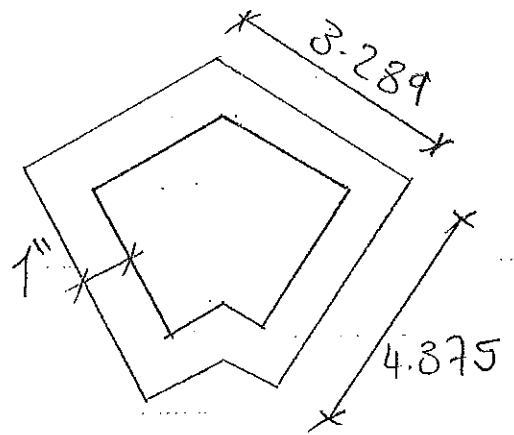

42" height

Anchors to Concrete

[5 - $\frac{3}{8}$ " ϕ Red head ITW or LDT
w/min 4" Embed & 3" edge distance
fc' \geq 3000]

Anchors to wood

[5 - $\frac{3}{8}$ " ϕ 12g screws w/6" Embed, min]



PROJECT NO. Eglass 217-2 SHEET _____ OF _____
PROJECT NAME _____ DESIGNED BY AS DATE _____
SUBJECT _____ CHECKED BY _____ DATE _____

Conclusion 4/7

No bracket

To Concrete

use [2 - $\frac{1}{2}$ " ϕ red head, 7" apart min
w/min 4" Embed. post to extend
2.5" below bottom anchor
fc & 3000 psi]

To wood:

use [2 - $\frac{3}{8}$ " ϕ lag screw, 7" apart w/min 4" Embed
post to extend 2.5" below bottom screw]



PROJECT NO. Egla 217 SHEET _____ OF _____
PROJECT NAME _____ DESIGNED BY AF DATE _____
SUBJECT _____ CHECKED BY _____ DATE _____

Conclusion 5/7

Intermediate post =

use [2-#10 tek screws to hold]
post in place

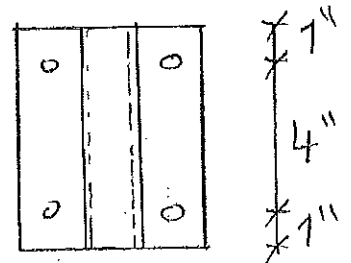

Bracket = As shown
 $t = \frac{3}{16}$ thick

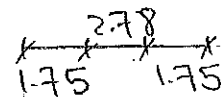

Anchor to Concrete

use [4- $\frac{3}{8}$ " ϕ Red head or LDT
w/ min 4" Embed, 3" edge distance
fc' \geq 2500 psi

To wood

use [4- $\frac{3}{8}$ " ϕ lag screws w/ 4" min Embed]



PROJECT NO. Eglass 217- SHEET _____ OF _____
PROJECT NAME _____ DESIGNED BY AF DATE _____
SUBJECT _____ CHECKED BY _____ DATE _____

Conclusion 6/7

outside corner bracket

Bracket = $\frac{3}{16}$ " thick, as shown

Anchor to concrete

use [4 - $\frac{1}{2}$ " ϕ Red head or LDT
w/min 3" Embed, 1.5" edge
distance, $f_c \leq 2500$ psi]

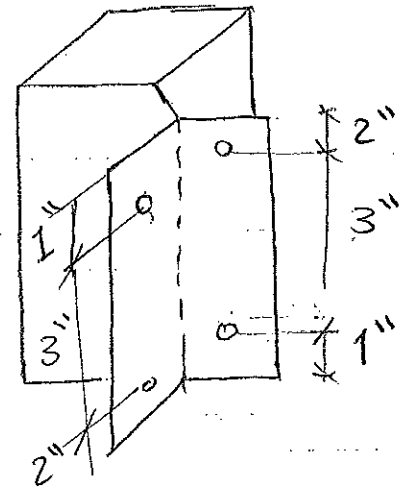

Anchor to wood

use [4 - $\frac{1}{2}$ " ϕ lag screws w/min 4" Embed]

Precision Structural Engineering, Inc.
250 Main Street, Suite A • Klamath Falls, OR 97601
Tel (541) 850-6300 • FAX (541) 850-6233

Medford Office
836 Mason Way (off Sage Road) • Medford, OR 97501
Tel (541) 858-8500

www.structure1.com • Email: info@structure1.com



PROJECT NO. Eglass 217 SHEET _____ OF _____
PROJECT NAME _____ DESIGNED BY AF DATE _____
SUBJECT _____ CHECKED BY _____ DATE _____

Conclusion 7/7

Inside Corner:

Post: $t = \frac{3}{16}$, AS shown
total length = 6"

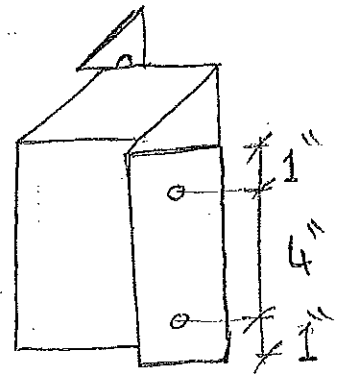

Anchor to Concrete:

Similar to outside corner

Anchor to wood

Similar to outside corner

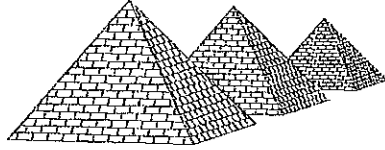

**Precision
Structural
Engineering, Inc.**

GUARD RAIL ANALYSIS & DESIGN:

Pages 1,000 - 1,999

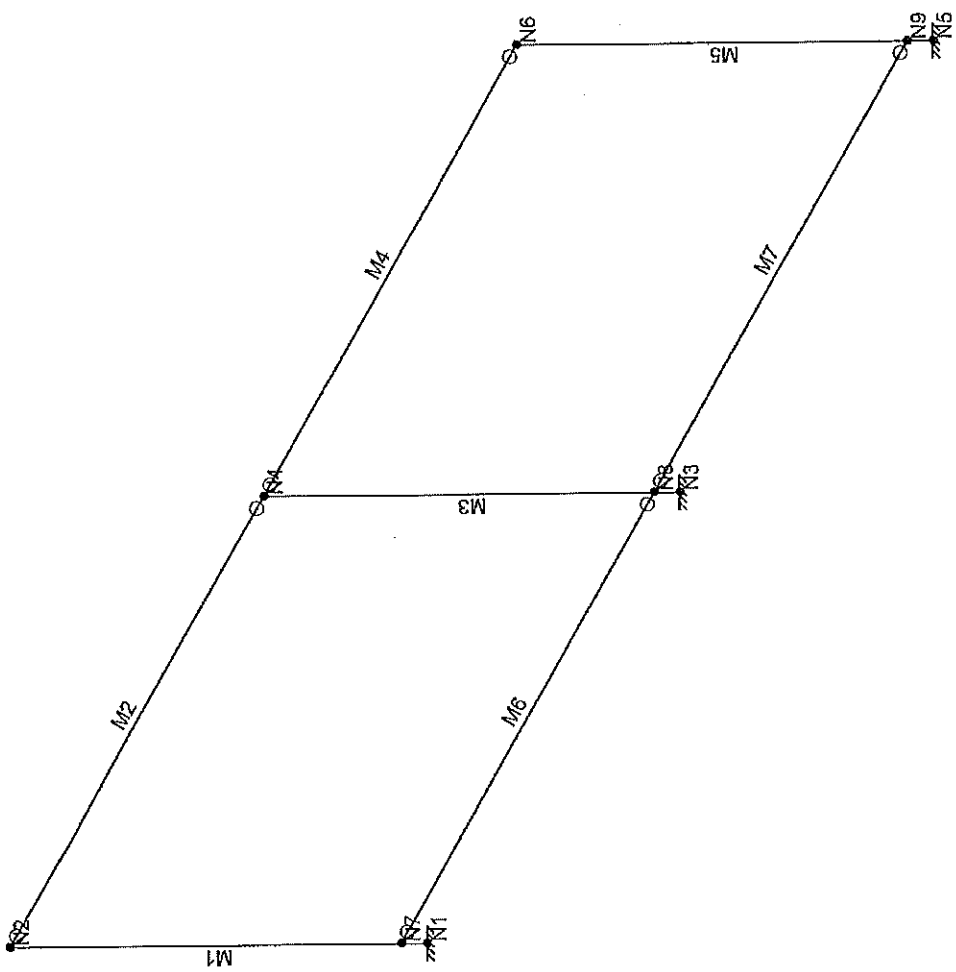
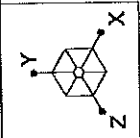

SK - 1
 Sept 22, 2017 at 9:28 AM
 Glass w-top and bottom rail.r3d

Glass W/ Top & Bottom Rail

PSEI
 AF
 Eglass 217-2

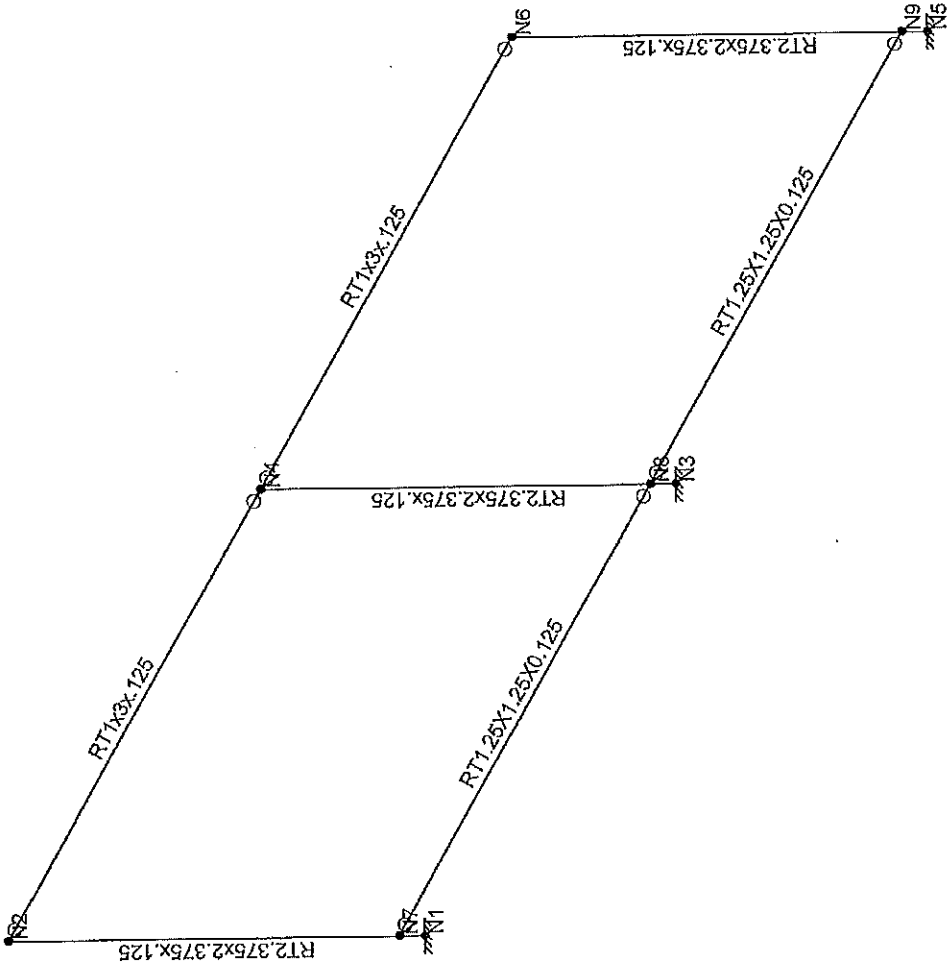
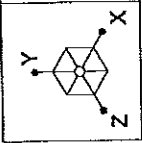

SK - 2
 Sept 22, 2017 at 9:28 AM
 Glass w-top and bottom rail.r3d

Glass W/ Top & Bottom Rail

PSEI

AF

Eglass 217-2

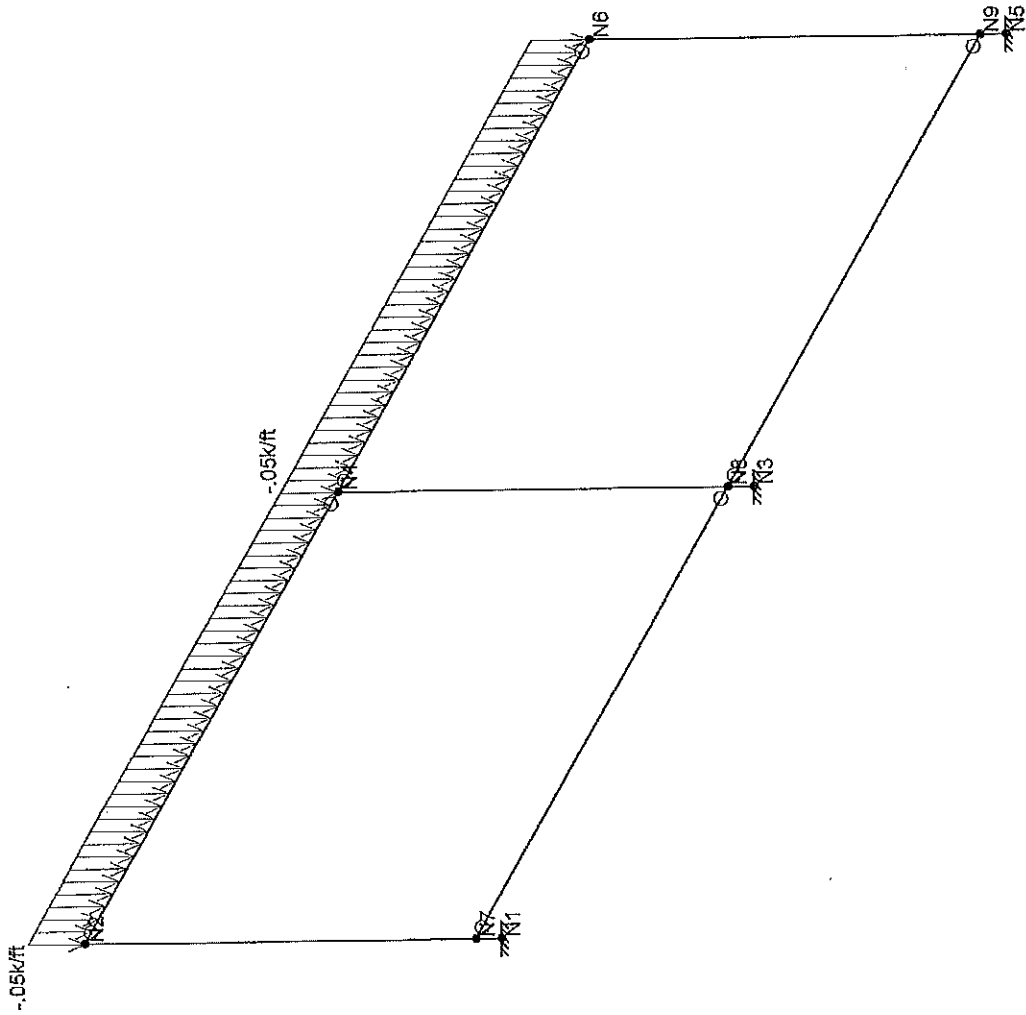
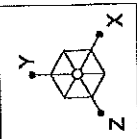

Loads: BLC 1, Distributed load-y at the top of

PSEI

AF

Eglass 217-2

SK - 3

Sept 22, 2017 at 9:29 AM

Glass w-top and bottom rail.r3d

Glass W/ Top & Bottom Rail

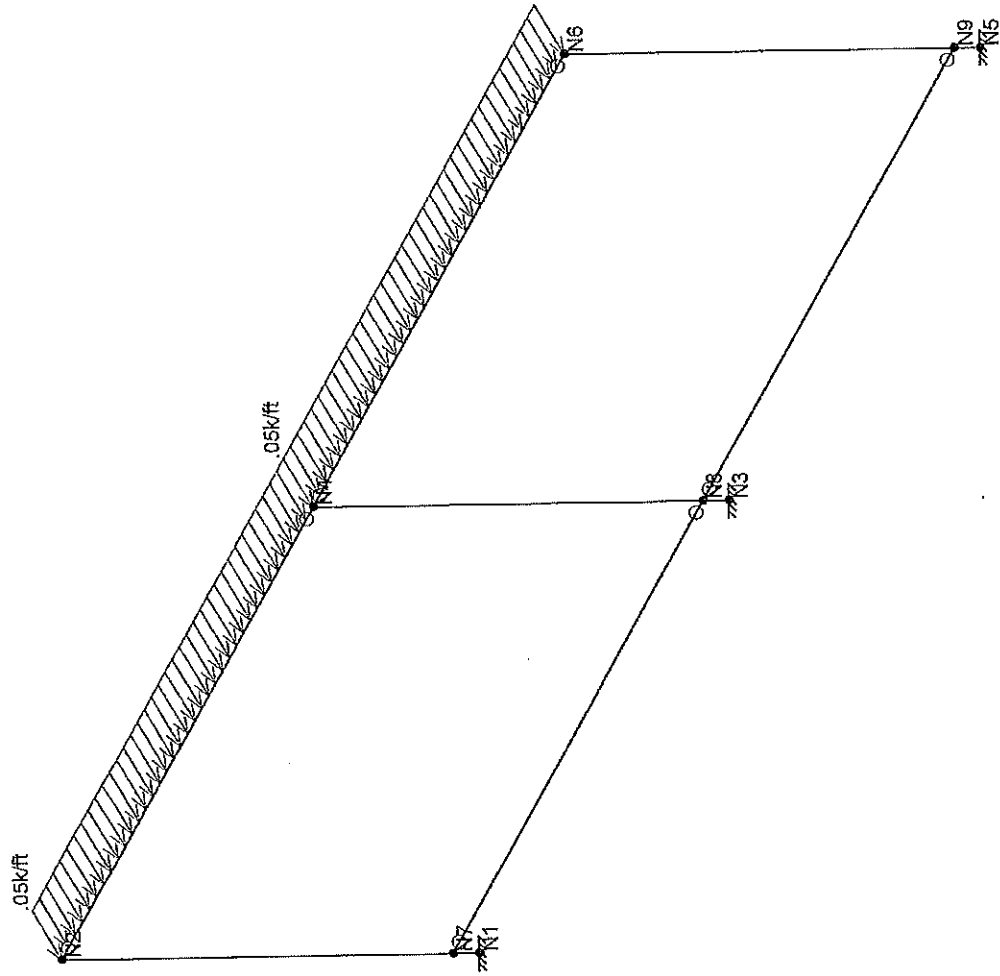
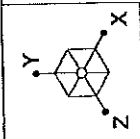

Loads: BLC 2, Distributed load-X at the side o

PSEI

AF

Eglass 217-2

SK - 4

Sept 22, 2017 at 9:29 AM

Glass w-top and bottom rail.r3d

Glass W/ Top & Bottom Rail

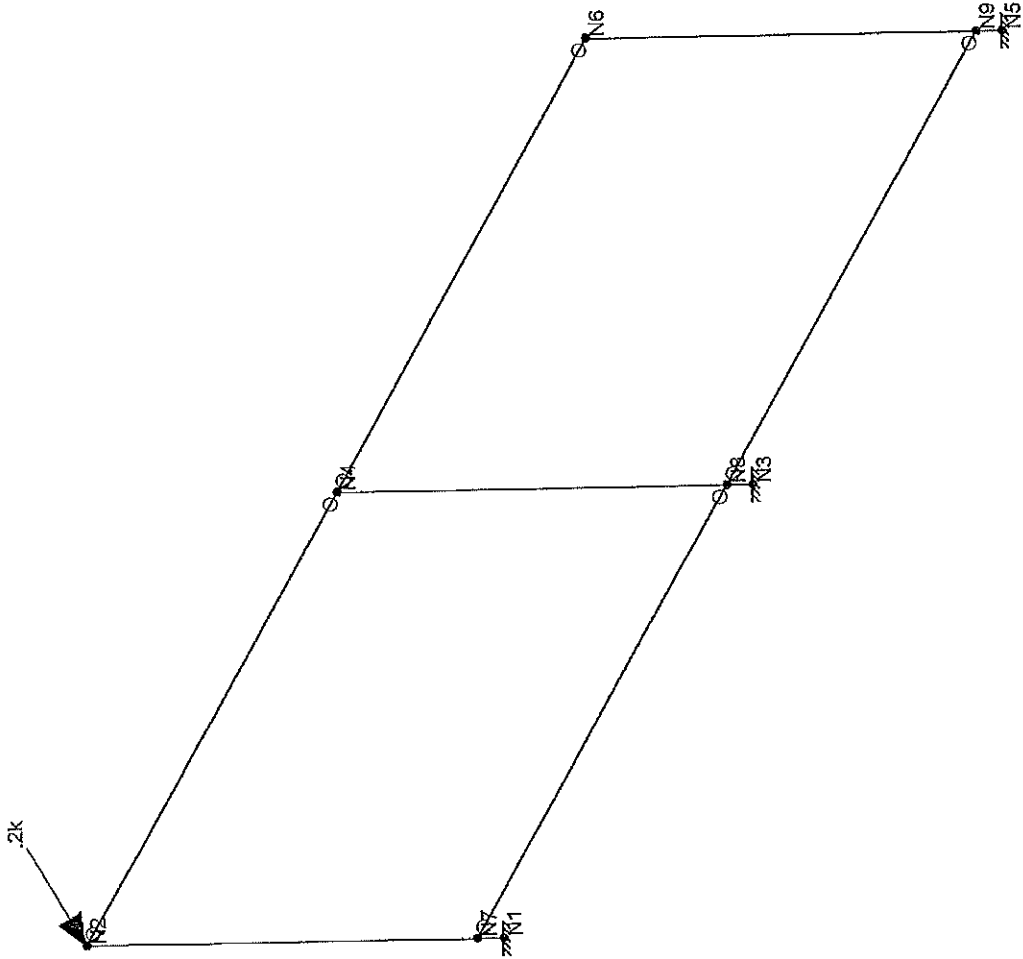
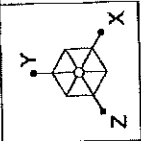

Loads: BLC 3, Point load applied at the corner

PSEI

AF

Eglass 217-2

SK - 5

Sept 22, 2017 at 9:29 AM

Glass w-top and bottom rail.r3d

Glass W/ Top & Bottom Rail

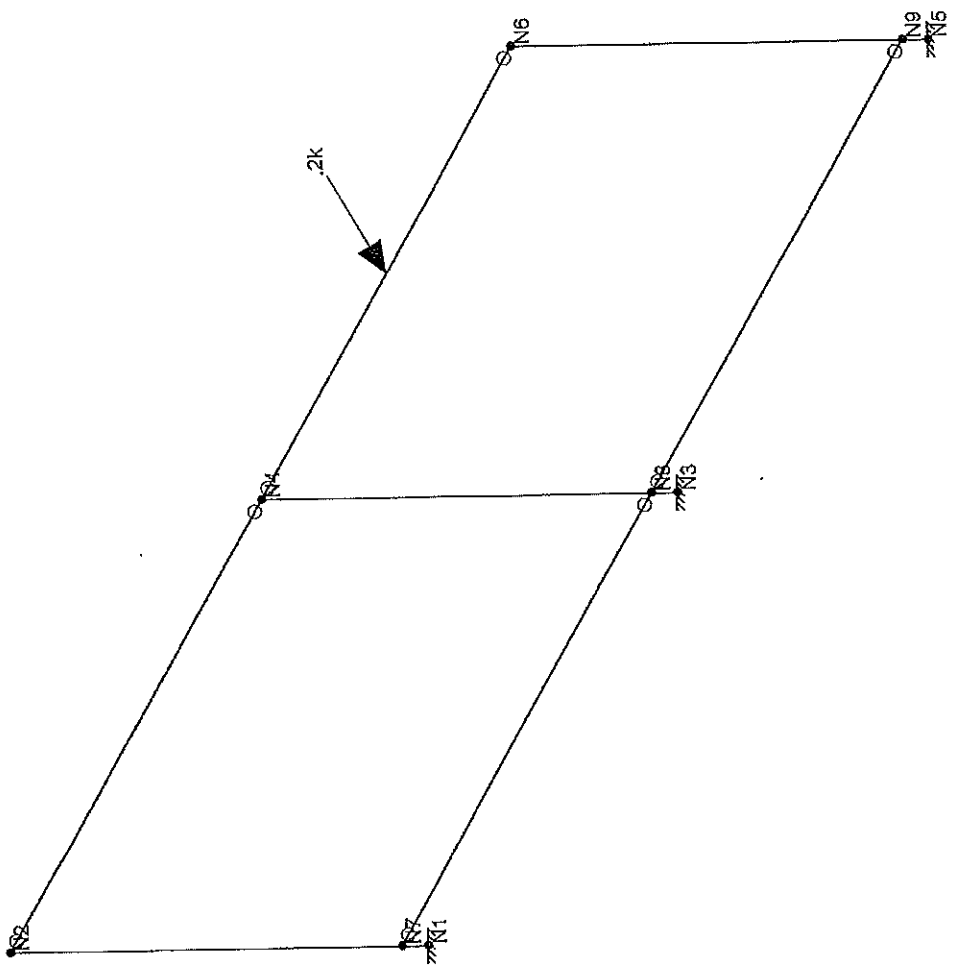
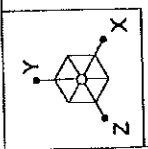

Loads: BLC 4, Point load applied at the middle

PSEI

AF

Eglass 217-2

SK - 6

Sept 22, 2017 at 9:29 AM

Glass w-top and bottom rail.r3d

Glass W/ Top & Bottom Rail

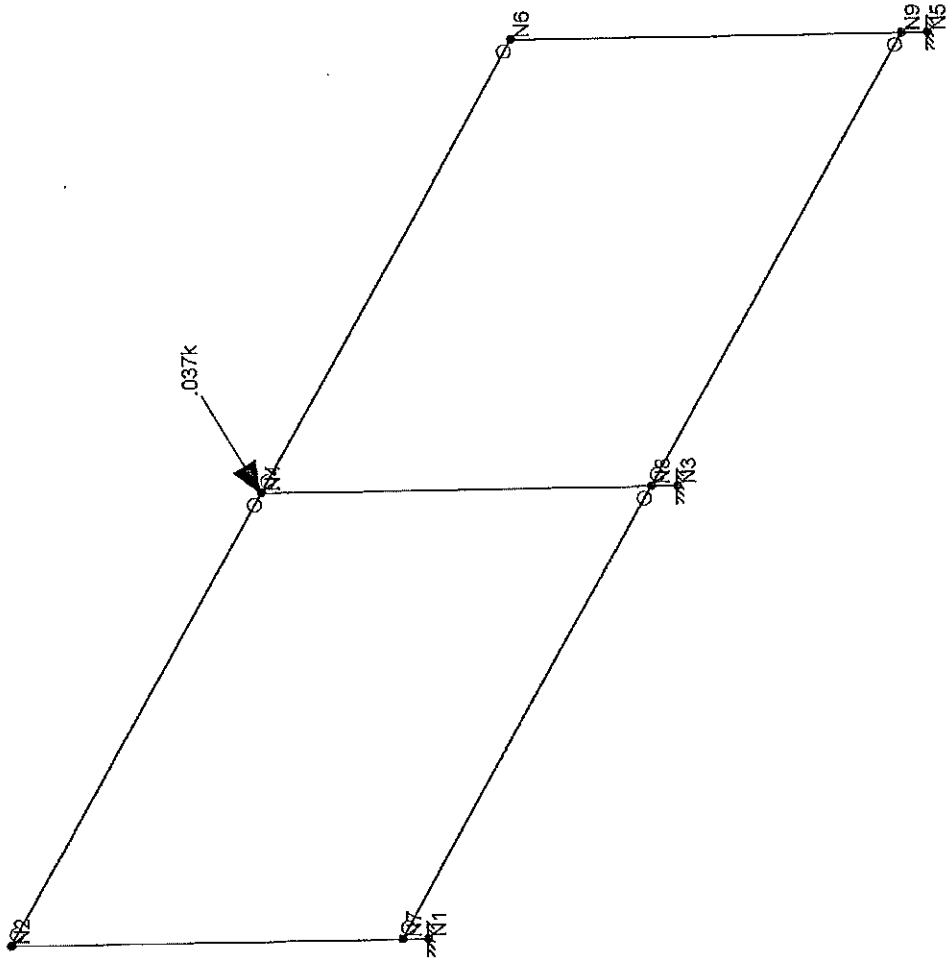
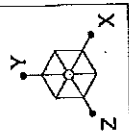

Loads: BLC 5, Infill

PSEI

AF

Eglass 217-2

SK - 7

Sept 22, 2017 at 9:29 AM

Glass w-top and bottom rail.r3d

Glass W/ Top & Bottom Rail

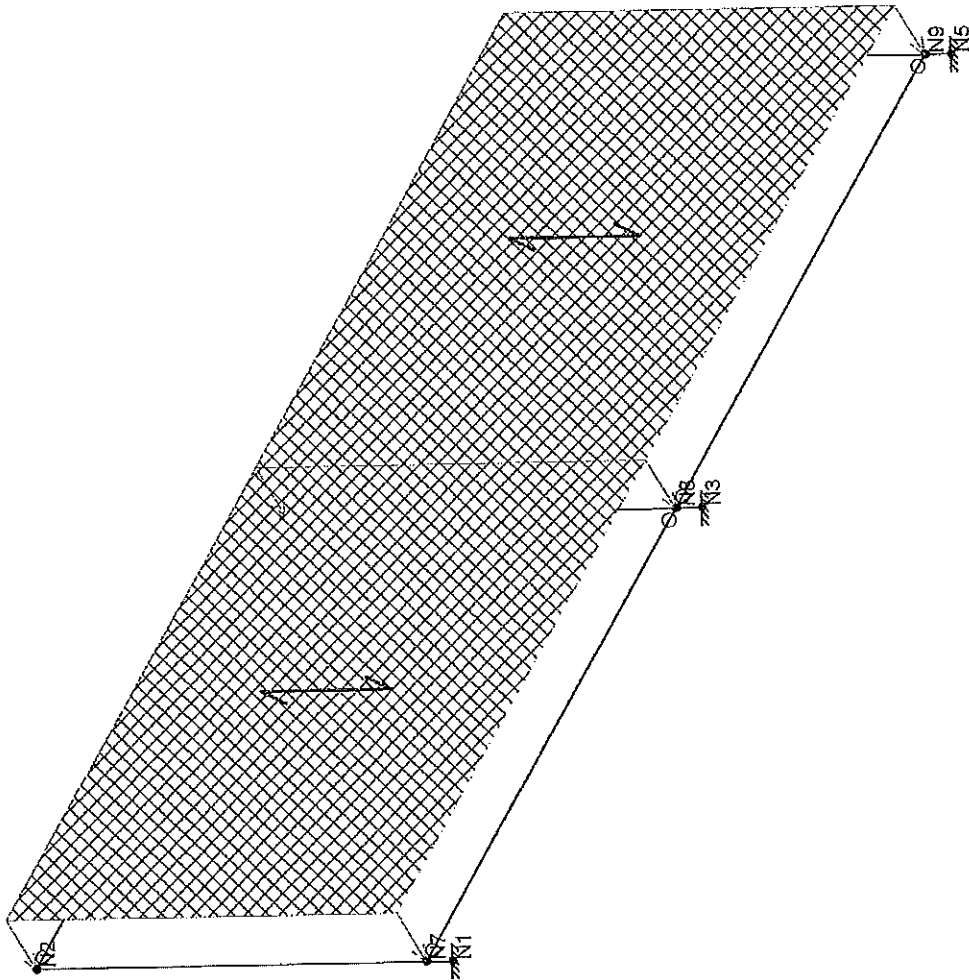
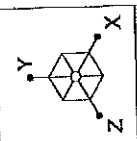

Loads: BLC 6, Wind

PSEI

AF

Eglass 217-2

SK - 8

Sept 22, 2017 at 9:29 AM

Glass w-top and bottom rail.r3d

Glass W/ Top & Bottom Rail

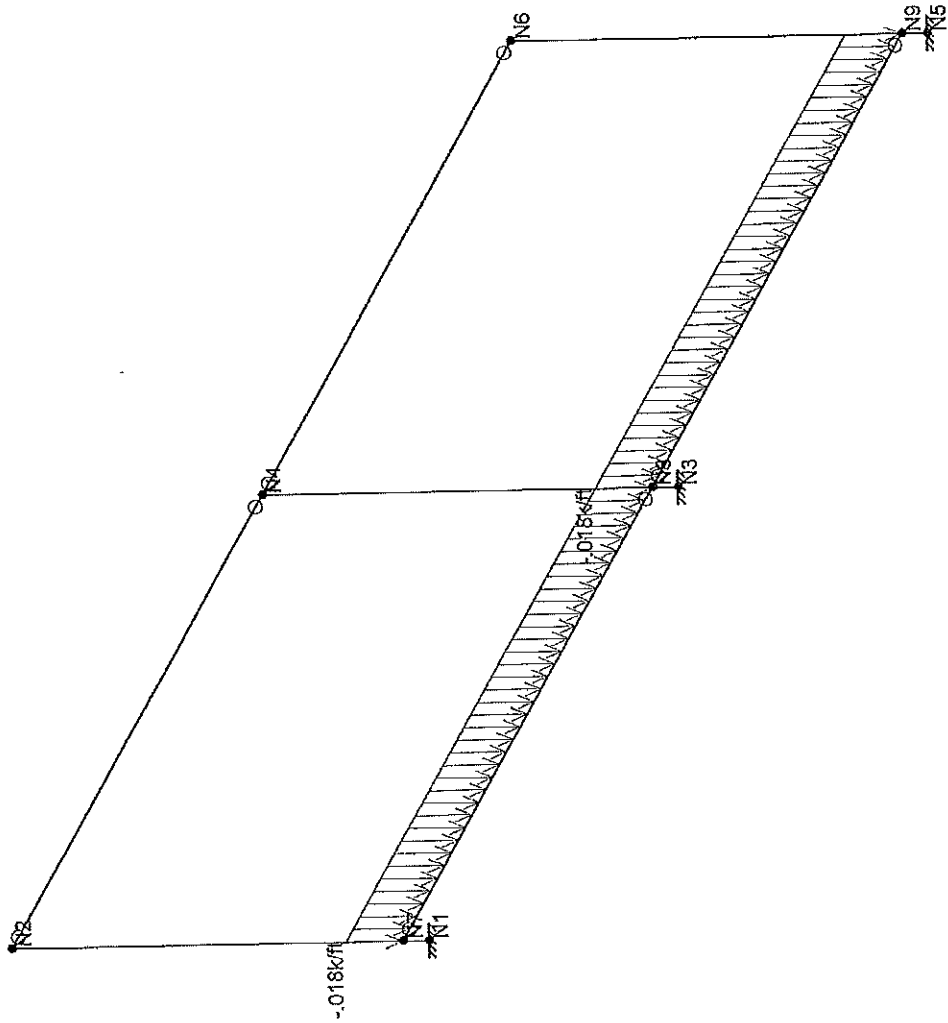
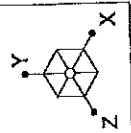

Loads: BLC 7, Glass Weigh

PSEI

AF

Eglass 217-2

SK - 9

Sept 22, 2017 at 9:29 AM

Glass w-top and bottom rail.r3d

Glass W/ Top & Bottom Rail

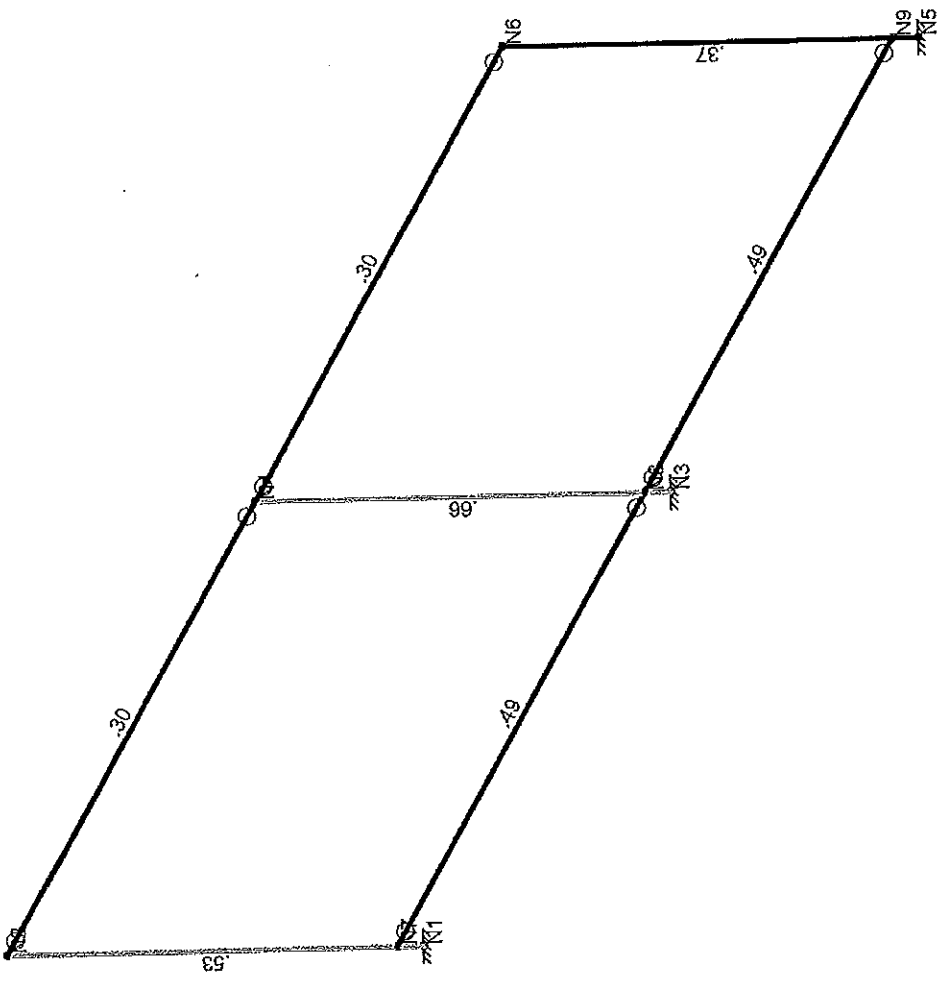
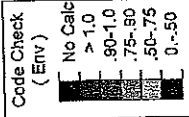
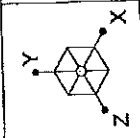

Member Code Checks Displayed (Enveloped)
Envelope Only Solution

PSEI

AF

Eglass 217-2

SK - 10

Sept 22, 2017 at 9:29 AM

Glass w-top and bottom rail.r3d

Glass W/ Top & Bottom Rail



Company : PSEI
 Designer : AF
 Job Number : Eglass 217-2
 Model Name : Glass W/ Top & Bottom Rail

Sept 22, 2017
 9:29 AM
 Checked By: _____

Aluminum Properties

	Label	E [ksi]	G [ksi]	Nu	Therm (...)	Density[...]	Table B.4	kt	Ftu[ksi]	Fty[ksi]	Fcy[ksi]	Fsu[ksi]	Ct
1	3003-H14	10100	3787.5	.33	1.3	.173	Table B...	1	19	16	13	12	141
2	6061-T6	10100	3787.5	.33	1.3	.173	Table B...	1	38	35	35	24	141
3	6063-T5	10100	3787.5	.33	1.3	.173	Table B...	1	22	16	16	13	141
4	6063-T6	10100	3787.5	.33	1.3	.173	Table B...	1	30	25	25	19	141
5	5052-H34	10200	3787.5	.33	1.3	.173	Table B...	1	34	26	24	20	141
6	6061-T6 W	10100	3787.5	.33	1.3	.173	Table B...	1	24	15	15	15	141

Aluminum Section Sets

	Label	Shape	Type	Design List	Material	Design R...	A [in2]	Iyy [in4]	Izz [in4]	J [in4]
1	POST	RT2.375x2.375x.125	Column	Rectangular Tub.	6061-T6	Typical	1.125	.952	.952	1.424
2	TOP RAIL	RT1x3x.125	Beam	Rectangular Tub.	6061-T6	Typical	.938	.153	.95	.422
3	BOTTOM RAIL	RT1.25X1.25X0.125	Beam	Rectangular Tub.	6061-T6	Typical	.563	.12	.12	.178

Joint Coordinates and Temperatures

	Label	X [ft]	Y [ft]	Z [ft]	Temp [F]	Detach From...
1	N1	0	0	0	0	
2	N2	0	4	0	0	
3	N3	5	0	0	0	
4	N4	5	4	0	0	
5	N5	10	0	0	0	
6	N6	10	4	0	0	
7	N7	0	.25	0	0	
8	N8	5	.25	0	0	
9	N9	10	.25	0	0	

Joint Boundary Conditions

	Joint Label	X [k/in]	Y [k/in]	Z [k/in]	X Rot.[k-ft/rad]	Y Rot.[k-ft/rad]	Z Rot.[k-ft/rad]
1	N1	Reaction	Reaction	Reaction	Reaction	Reaction	Reaction
2	N3	Reaction	Reaction	Reaction	Reaction	Reaction	Reaction
3	N5	Reaction	Reaction	Reaction	Reaction	Reaction	Reaction

Aluminum Design Parameters

	Label	Shape	Length[ft]	Lbyy[ft]	Lbzz[ft]	Lcomp top[ft]	Lcomp bot[ft]	L-torq...	Kyy	Kzz	Cb	Functi...
1	M1	POST	4			Lbyy						Lateral
2	M2	TOP RAIL	5			Lbyy						Lateral
3	M3	POST	4			Lbyy						Lateral
4	M4	TOP RAIL	6			Lbyy						Lateral
5	M5	POST	4			Lbyy						Lateral
6	M6	BOTTOM RAIL	5			Lbyy						Lateral
7	M7	BOTTOM RAIL	5			Lbyy						Lateral

Basic Load Cases

	BLC Description	Category	X Gravity	Y Gravity	Z Gravity	Joint	Point	Distribu.	Area(M...	Surface...
1	Distributed load-y at the top of	None		-1				2		
2	Distributed load-X at the side o	None		-1				2		
3	Point load applied at the corner	None		-1		1				
4	Point load applied at the middle	None		-1			1			
5	Infill	None				1				



Company : PSEI
 Designer : AF
 Job Number : Eglass 217-2
 Model Name : Glass W/ Top & Bottom Rail

Sept 22, 2017
 9:29 AM
 Checked By: _____

Basic Load Cases (Continued)

	BLC Description	Category	X Gravity	Y Gravity	Z Gravity	Joint	Point	Distribu.	Area(M... Surface...
6	Wind	None						2	2
7	Glass Weigh	None						2	
8	BLC 6 Transient Area Loads	None						4	

Member Distributed Loads (BLC 1 : Distributed load-y at the top of)

	Member Label	Direction	Start Magnitude[k/ft....	End Magnitude[k/ft.F...	Start Location[ft.%]	End Location[ft.%]
1	M2	Y	-05	-05	0	0
2	M4	Y	-05	-05	0	0

Member Distributed Loads (BLC 2 : Distributed load-X at the side o)

	Member Label	Direction	Start Magnitude[k/ft....	End Magnitude[k/ft.F...	Start Location[ft.%]	End Location[ft.%]
1	M2	Z	05	05	0	0
2	M4	Z	05	05	0	0

Member Distributed Loads (BLC 7 : Glass Weigh)

	Member Label	Direction	Start Magnitude[k/ft....	End Magnitude[k/ft.F...	Start Location[ft.%]	End Location[ft.%]
1	M6	Y	-018	-018	0	0
2	M7	Y	-018	-018	0	0

Member Distributed Loads (BLC 8 : BLC 6 Transient Area Loads)

	Member Label	Direction	Start Magnitude[k/ft....	End Magnitude[k/ft.F...	Start Location[ft.%]	End Location[ft.%]
1	M2	Z	058	058	4.441e-16	5
2	M6	Z	058	058	0	5
3	M4	Z	058	058	4.441e-16	5
4	M7	Z	058	058	0	5

Joint Loads and Enforced Displacements (BLC 3 : Point load applied at the corner)

	Joint Label	L,D,M	Direction	Magnitude[(k,k-ft), (in.rad), (k*s^2/ft, k*s^2*ft)]
1	N2	L	Z	.2

Joint Loads and Enforced Displacements (BLC 5 : Infill)

	Joint Label	L,D,M	Direction	Magnitude[(k,k-ft), (in.rad), (k*s^2/ft, k*s^2*ft)]
1	N4	L	Z	.037

Member Area Loads (BLC 6 : Wind)

	Joint A	Joint B	Joint C	Joint D	Direction	Distribution	Magnitude[k/ksf]
1	N7	N2	N4	N8	Z	A-B	.031
2	N8	N4	N6	N9	Z	A-B	.031

Load Combinations

	Description	S...	P...	S...	B...	Fa...	BLC Fac...	B...	Fa...	B...	Fa...	B...	Fa...	B...	Fa...	B...	Fa...	B...	Fa...	B...	Fa...	
1	Distributed load-y at the t...	Yes	Y	1	1	7	1															
2	Distributed load-X at the ...	Yes	Y	2	1	7	1															
3	Point load applied at the ...	Yes	Y	3	1	7	1															
4	Point load applied at the ...	Yes	Y	4	1	7	1															
5	Infill	Yes	Y	5	1	7	1															
6	Wind	Yes	Y	6	6	7	1															



Company : PSEI
 Designer : AF
 Job Number : Eglass 217-2
 Model Name : Glass W/ Top & Bottom Rail

Sept 22, 2017
 9:29 AM
 Checked By: _____

Envelope Joint Reactions

Joint	X [k]	LC	Y [k]	LC	Z [k]	LC	MX [k-ft]	LC	MY [k-ft]	LC	MZ [k-ft]	LC
1 N1 max	0	1	.18	1	0	1	0	1	0	1	0	1
2 min	0	1	.045	5	-.2	3	-.747	3	0	1	0	1
3 N3 max	0	1	.354	1	0	1	0	1	0	1	0	1
4 min	0	1	.089	5	-.349	6	-.942	2	0	1	0	1
5 N5 max	0	1	.179	1	0	5	0	1	0	1	0	1
6 min	0	1	.044	5	-.174	6	-.53	2	0	1	0	1
7 Totals: max	0	1	.713	1	0	1						
8 min	0	1	.178	5	-.698	6						

Envelope Member Section Forces

Member	Sec	Axial[k]	LC	y Shear[k]	LC	z Shear[k]	LC	Torque[k-ft]	LC	y-y Mome...	LC	z-z Mome...	LC
1 M1	1	max .18	1	0	1	0	1	0	1	.747	3	0	1
2		min .045	5	0	1	-.2	3	0	1	0	1	0	1
3	2	max .132	1	0	1	0	1	0	1	.55	3	0	1
4		min 0	5	0	1	-.2	3	0	1	0	1	0	1
5	3	max .131	1	0	1	0	1	0	1	.35	3	0	1
6		min 0	5	0	1	-.2	3	0	1	0	1	0	1
7	4	max .129	1	0	1	0	1	0	1	.153	2	0	1
8		min 0	5	0	1	-.2	3	0	1	0	1	0	1
9	5	max .128	1	0	1	0	1	0	1	.028	2	0	1
10		min 0	5	0	1	-.2	3	0	1	-.051	3	0	1
11 M2	1	max 0	1	0	1	0	5	.051	3	0	1	0	1
12		min 0	1	-.125	2	.128	1	-.028	2	0	1	0	1
13	2	max 0	1	0	1	0	5	.051	3	0	5	.117	2
14		min 0	1	-.063	2	-.064	1	-.028	2	-.12	1	0	1
15	3	max 0	1	0	1	0	1	.051	3	0	5	.156	2
16		min 0	1	0	1	0	1	-.028	2	-.16	1	0	1
17	4	max 0	1	.063	2	.064	1	.051	3	0	5	.117	2
18		min 0	1	0	1	0	5	-.028	2	-.12	1	0	1
19	5	max 0	1	.125	2	.128	1	.051	3	0	1	0	1
20		min 0	1	0	1	0	5	-.028	2	0	1	0	1
21 M3	1	max .256	1	0	1	0	1	0	1	.055	2	0	1
22		min 0	5	0	1	-.25	2	0	1	-.044	3	0	1
23	2	max .257	1	0	1	0	1	0	1	0	1	0	1
24		min 0	5	0	1	-.25	2	0	1	-.195	2	0	1
25	3	max .258	1	0	1	0	1	0	1	0	1	0	1
26		min 0	5	0	1	-.25	2	0	1	-.445	2	0	1
27	4	max .26	1	0	1	0	1	0	1	0	1	0	1
28		min 0	5	0	1	-.25	2	0	1	-.695	2	0	1
29	5	max .354	1	0	1	0	1	0	1	0	1	0	1
30		min .089	5	0	1	-.349	6	0	1	-.942	2	0	1
31 M4	1	max 0	1	0	1	0	5	.028	2	0	1	0	1
32		min 0	1	-.125	2	-.128	1	-.003	4	0	1	0	1
33	2	max 0	1	0	1	0	5	.028	2	0	5	.125	4
34		min 0	1	-.1	4	-.064	1	-.003	4	-.12	1	0	1
35	3	max 0	1	.1	4	0	1	.028	2	0	5	.25	4
36		min 0	1	0	1	0	1	-.003	4	-.16	1	0	1
37	4	max 0	1	.1	4	.064	1	.028	2	0	5	.125	4
38		min 0	1	0	1	0	5	-.003	4	-.12	1	0	1
39	5	max 0	1	.125	2	.128	1	.028	2	0	1	0	1
40		min 0	1	0	1	0	5	-.003	4	0	1	0	1
41 M5	1	max .128	1	0	1	0	1	0	1	.003	4	0	1
42		min 0	5	0	1	-.125	2	0	1	-.028	2	0	1
43	2	max .129	1	0	1	0	1	0	1	0	1	0	1



Company : PSEI
 Designer : AF
 Job Number : Eglass 217-2
 Model Name : Glass W/ Top & Bottom Rail

Sept 22, 2017
 9:29 AM
 Checked By: _____

Envelope Member Section Forces (Continued)

Member	Sec		Axial[k]	LC	y Shear[k]	LC	z Shear[k]	LC	Torque[k-ft]	LC	y-v Mome...	LC	z-z Mome...	LC	
44		min	0	5	0	1	-.125	2	0	1	-.153	2	0	1	
45		max	.131	1	0	1	0	1	0	1	0	1	0	1	
46	3	min	0	5	0	1	-.125	2	0	1	-.278	2	0	1	
47		max	.132	1	0	1	0	1	0	1	0	1	0	1	
48	4	min	0	5	0	1	-.125	2	0	1	-.403	2	0	1	
49		max	.179	1	0	1	0	1	0	1	0	1	0	1	
50	5	min	.044	5	0	1	-.174	6	0	1	-.53	2	0	1	
51	M6	1	max	0	1	.047	1	0	1	.003	3	0	1	0	1
52		min	0	1	.045	5	-.087	6	-.002	2	0	1	0	1	
53	2	max	0	1	.023	1	0	1	.003	3	0	1	-.042	5	
54		min	0	1	.022	5	-.044	6	-.002	2	-.082	6	-.044	1	
55	3	max	0	1	0	1	0	1	.003	3	0	1	-.056	5	
56		min	0	1	0	1	0	1	-.002	2	-.109	6	-.058	1	
57	4	max	0	1	-.022	5	.044	6	.003	3	0	1	-.042	5	
58		min	0	1	-.023	1	0	1	-.002	2	-.082	6	-.043	1	
59	5	max	0	1	-.045	5	.087	6	.003	3	0	1	0	1	
60		min	0	1	-.046	1	0	1	-.002	2	0	1	0	1	
61	M7	1	max	0	1	.046	1	0	1	.002	2	0	1	0	1
62		min	0	1	.044	5	-.087	6	0	4	0	1	0	1	
63	2	max	0	1	.023	1	0	1	.002	2	0	1	-.042	5	
64		min	0	1	.022	5	-.044	6	0	4	-.082	6	-.043	1	
65	3	max	0	1	0	1	0	1	.002	2	0	1	-.056	5	
66		min	0	1	0	1	0	1	-.002	2	-.109	6	-.058	1	
67	4	max	0	1	-.022	5	.044	6	.002	2	0	1	-.042	5	
68		min	0	1	-.023	1	0	1	0	4	-.082	6	-.043	1	
69	5	max	0	1	-.044	5	.087	6	.002	2	0	1	0	1	
70		min	0	1	-.046	1	0	1	0	4	0	1	0	1	

Envelope Member Section Deflections

Member	Sec		x [in]	LC	y [in]	LC	z [in]	LC	x Rotate [r...	LC	(n) L/y Ratio	LC	(n) L/z Ratio	LC	
1	M1	1	max	0	1	0	1	0	1	0	1	NC	1	NC	1
2		min	0	1	0	1	0	1	0	1	NC	1	NC	1	
3	2	max	0	5	0	1	.078	3	0	1	NC	1	NC	1	
4		min	0	1	0	1	0	1	0	1	NC	1	616.91	3	
5	3	max	0	5	0	1	.279	3	0	1	NC	1	NC	1	
6		min	0	1	0	1	0	1	0	1	NC	1	172	3	
7	4	max	0	5	0	1	.559	3	0	1	NC	1	NC	1	
8		min	0	1	0	1	0	1	0	1	NC	1	85.888	3	
9	5	max	0	5	0	1	.872	3	0	1	NC	1	NC	1	
10		min	0	1	0	1	0	1	0	1	NC	1	55.03	3	
11	M2	1	max	0	1	.872	3	0	1	2.617e-02	3	NC	1	NC	1
12		min	0	1	0	1	0	5	0	1	NC	1	NC	1	
13	2	max	0	1	.831	2	.414	1	2.394e-02	2	NC	1	NC	5	
14		min	0	1	0	1	0	5	0	1	919.513	2	145.104	1	
15	3	max	0	1	.97	2	.581	1	2.707e-02	2	NC	1	NC	5	
16		min	0	1	0	1	0	5	0	1	655.153	2	103.387	1	
17	4	max	0	1	1.057	2	.415	1	3.019e-02	2	NC	1	NC	5	
18		min	0	1	0	1	0	5	0	1	919.513	2	145.104	1	
19	5	max	0	1	1.105	2	.001	1	3.331e-02	2	NC	1	NC	1	
20		min	0	1	0	1	0	5	0	1	NC	1	NC	1	
21	M3	1	max	.001	1	0	1	0	1	0	1	NC	1	NC	1
22		min	0	5	0	1	-.1105	2	0	1	NC	1	43.437	2	
23	2	max	.001	1	0	1	0	1	0	1	NC	1	NC	1	
24		min	0	5	0	1	-.707	2	0	1	NC	1	67.899	2	
25	3	max	0	1	0	1	0	1	0	1	NC	1	NC	1	



Company : PSEI
 Designer : AF
 Job Number : Eglass 217-2
 Model Name : Glass W/ Top & Bottom Rail

Sept 22, 2017
 9:29 AM
 Checked By: _____

Envelope Member Section Deflections (Continued)

Member	Sec	x (in)	LC	v (in)	LC	z (in)	LC	x Rotate fr...	LC	(n) L/y Ratio	LC	(n) L/z Ratio	LC		
26		min	0	5	0	1	-353	2	0	1	NC	1	136.143	2	
27	4	max	0	1	0	1	0	1	0	1	NC	1	NC	1	
28		min	0	5	0	1	-.098	2	0	1	NC	1	488.788	2	
29	5	max	0	1	0	1	0	1	0	1	NC	1	NC	1	
30		min	0	1	0	1	0	1	0	1	NC	1	NC	1	
31	M4	1	max	0	1	1.105	2	.001	1	3.331e-02	2	NC	1	NC	1
32		min	0	1	0	1	0	5	0	1	NC	1	NC	1	
33	2	max	0	1	1.057	2	.415	1	3.019e-02	2	NC	1	NC	5	
34		min	0	1	0	1	0	5	0	1	744.492	4	145.104	1	
35	3	max	0	1	.97	2	.581	1	2.707e-02	2	NC	1	NC	5	
36		min	0	1	0	1	0	5	0	1	511.838	4	103.387	1	
37	4	max	0	1	.831	2	.414	1	2.394e-02	2	NC	1	NC	5	
38		min	0	1	0	1	0	5	0	1	744.492	4	145.104	1	
39	5	max	0	1	.653	2	0	1	2.082e-02	2	NC	1	NC	1	
40		min	0	1	0	1	0	5	0	1	NC	1	NC	1	
41	M5	1	max	0	1	0	1	0	1	0	1	NC	1	NC	1
42		min	0	5	0	1	-.653	2	0	1	NC	1	73.534	2	
43	2	max	0	1	0	1	0	1	0	1	NC	1	NC	1	
44		min	0	5	0	1	-.41	2	0	1	NC	1	117.081	2	
45	3	max	0	1	0	1	0	1	0	1	NC	1	NC	1	
46		min	0	5	0	1	-.202	2	0	1	NC	1	238.202	2	
47	4	max	0	1	0	1	0	1	0	1	NC	1	NC	1	
48		min	0	5	0	1	-.055	2	0	1	NC	1	865.08	2	
49	5	max	0	1	0	1	0	1	0	1	NC	1	NC	1	
50		min	0	1	0	1	0	1	0	1	NC	1	NC	1	
51	M6	1	max	0	1	0	5	.005	3	3.379e-03	3	NC	1	NC	1
52		min	0	1	0	1	0	1	0	1	NC	1	NC	1	
53	2	max	0	1	-.185	5	.364	6	2.871e-03	2	324.293	5	NC	1	
54		min	0	1	-.192	1	0	1	0	1	312.501	1	166.488	6	
55	3	max	0	1	-.26	5	.51	6	3.335e-03	2	231.115	5	NC	1	
56		min	0	1	-.269	1	0	1	0	1	222.709	1	118.623	6	
57	4	max	0	1	-.185	5	.365	6	3.799e-03	2	324.452	5	NC	1	
58		min	0	1	-.192	1	0	1	0	1	312.648	2	166.488	6	
59	5	max	0	1	0	5	.007	2	4.263e-03	2	NC	1	NC	1	
60		min	0	1	0	1	0	1	0	1	NC	1	NC	1	
61	M7	1	max	0	1	0	5	.007	2	4.263e-03	2	NC	1	NC	1
62		min	0	1	0	1	0	1	0	1	NC	1	NC	1	
63	2	max	0	1	-.184	5	.365	6	3.799e-03	2	326.194	5	NC	1	
64		min	0	1	-.191	1	0	1	0	1	314.266	1	166.488	6	
65	3	max	0	1	-.258	5	.51	6	3.335e-03	2	232.413	5	NC	1	
66		min	0	1	-.268	1	0	1	0	1	223.915	1	118.623	6	
67	4	max	0	1	-.184	5	.364	6	2.871e-03	2	326.194	5	NC	1	
68		min	0	1	-.191	1	0	1	0	1	314.266	1	166.488	6	
69	5	max	0	1	0	5	.004	2	2.407e-03	2	NC	1	NC	1	
70		min	0	1	0	1	0	1	0	1	NC	1	NC	1	

Envelope AA ADM1-10: ASD - Building Aluminum Code Checks

Member	Shape	Code C...	Loc[ft]	LC	Shear ...	Loc[ft]	Dir	LC	Pnc/O...	Pnt/Om...	Mny/O...	Mnz/O...	Vny/O...	Vnz/O...	Cb	Eqn	
1	M1	RT2.375x...	.527	0	3	.031	25	z	3	15.383	21.923	1.417	1.417	6.364	6.364	1	H.1-1
2	M2	RT1X3x1...	.300	2.5	1	.123	0	z	3	2.187	18.269	.533	1.042	8.352	1.989	1	H.1-1
3	M3	RT2.375x...	.665	4	2	.055	3.75	z	6	15.383	21.923	1.417	1.417	6.364	6.364	1	H.1-1
4	M4	RT1x3x1...	.300	2.5	1	.068	0	z	2	2.187	18.269	.533	1.042	8.352	1.989	1	H.1-1
5	M5	RT2.375x...	.374	4	2	.027	3.75	z	6	15.383	21.923	1.417	1.417	6.364	6.364	1	H.1-1
6	M6	RT1.25X...	.487	2.5	6	.037	0	z	6	1.712	10.971	.339	.337	2.784	2.784	1	H.1-1
7	M7	RT1.25X...	.486	2.5	6	.037	0	z	6	1.712	10.971	.339	.337	2.784	2.784	1	H.1-1



Company : PSEI
 Designer : AF
 Job Number : Eglass 217-2
 Model Name : Glass W/ Top & Bottom Rail

Sept 22, 2017
 9:30 AM
 Checked By: _____

Joint Reactions (By Combination)

	LC	Joint Label	X [k]	Y [k]	Z [k]	MX [k-ft]	MY [k-ft]	MZ [k-ft]
1	1	N1	0	.18	0	0	0	0
2	1	N3	0	.354	0	0	0	0
3	1	N5	0	.179	0	0	0	0
4	1	Totals:	0	.713	0			
5	1	COG (ft):	X: 4.998	Y: 2.98	Z: 0			
6	2	N1	0	.055	-.125	-.53	0	0
7	2	N3	0	.104	-.25	-.942	0	0
8	2	N5	0	.054	-.125	-.53	0	0
9	2	Totals:	0	.213	-.5			
10	2	COG (ft):	X: 4.992	Y: .582	Z: 0			
11	3	N1	0	.055	-.2	-.747	0	0
12	3	N3	0	.104	0	-.047	0	0
13	3	N5	0	.054	0	-.007	0	0
14	3	Totals:	0	.213	-.2			
15	3	COG (ft):	X: 4.992	Y: .582	Z: 0			
16	4	N1	0	.055	0	-.027	0	0
17	4	N3	0	.104	-.1	-.377	0	0
18	4	N5	0	.054	-.1	-.397	0	0
19	4	Totals:	0	.213	-.2			
20	4	COG (ft):	X: 4.992	Y: .582	Z: 0			
21	5	N1	0	.045	0	-.009	0	0
22	5	N3	0	.089	-.038	-.132	0	0
23	5	N5	0	.044	0	-.009	0	0
24	5	Totals:	0	.178	-.038			
25	5	COG (ft):	X: 4.991	Y: .25	Z: 0			
26	6	N1	0	.045	-.174	-.391	0	0
27	6	N3	0	.089	-.349	-.7	0	0
28	6	N5	0	.044	-.174	-.391	0	0
29	6	Totals:	0	.178	-.698			
30	6	COG (ft):	X: 4.991	Y: .25	Z: 0			

Glass Load Resistance Report --

Friday, September 22, 2017

Glazing Information

Edge Supports: 2 Sides
Glazing Angle: 90°
Lite Dimensions:
 Unsupported Length: 60.0 in.
 Supported Length: 42.0 in.

Project Details

Project Name:
Location:
Comments:

Glass Construction (Rectangular)

Single Glazed Lite

Glass Type: Fully Tempered
Nominal Thickness: 5/16 in.

Short Load Duration, Resistance, and Deflection Data

Load (~ 3 sec.): 31.0 psf
Load Resistance: 43.7 psf
Approximate center of glass deflection: 1.68 in.

Long Load Duration, Resistance, and Deflection Data

Load (~ 30 days): 13.2 psf
Load Resistance: 32.8 psf
Approximate center of glass deflection: 0.72 in.

Conclusion

Based on your design information, the load resistance is greater than or equal to the specified loading.

Statement of Compliance

Procedures followed in determining the resistance of this window glass are in accordance with ASTM E1300-09/12.

Disclaimer:

This software can be used to determine the load resistance of specified glass types exposed to uniform lateral loads of short or long duration subject to the following conditions:

- The glass is free of edge and surface damage and has been properly glazed in the opening in conformance with the manufacturer's recommendations.
 - Procedures exist to determine load resistance for rectangular glass assemblies that are:
 - a. Continuously supported along all four edges,
 - b. Continuously supported along three edges,
 - c. Continuously supported along two parallel edges, and
 - d. Continuously supported along one edge.
 - The software user has the responsibility of selecting the correct procedures for the required application from the software.
 - The stiffness of members supporting any glass edge shall be sufficient that under design load, edge deflections shall not exceed $L/175$, where L denotes that length of the supported edge.
 - The manufacturer states that the Safety Plus II 0.090 Polyurethane Large Missile Resistant interlayer is comparable to the PVB interlayer.
- For other limiting conditions that may apply, refer to Section 5 of ASTM E1300 and local building codes.

Neither SDG nor GANA guarantees and each disclaims any responsibility for any particular results relating to the use of the Window Glass Design 5 Software Program. SDG and GANA disclaim any liability for any personal injury or any loss or damage of any kind, including all indirect, special, or consequential damages and lost profits, arising out of or relating to the use of the Window Glass Design 5 Software Program.

Prepared by: _____ on 4/5/2017

Lite Sketch

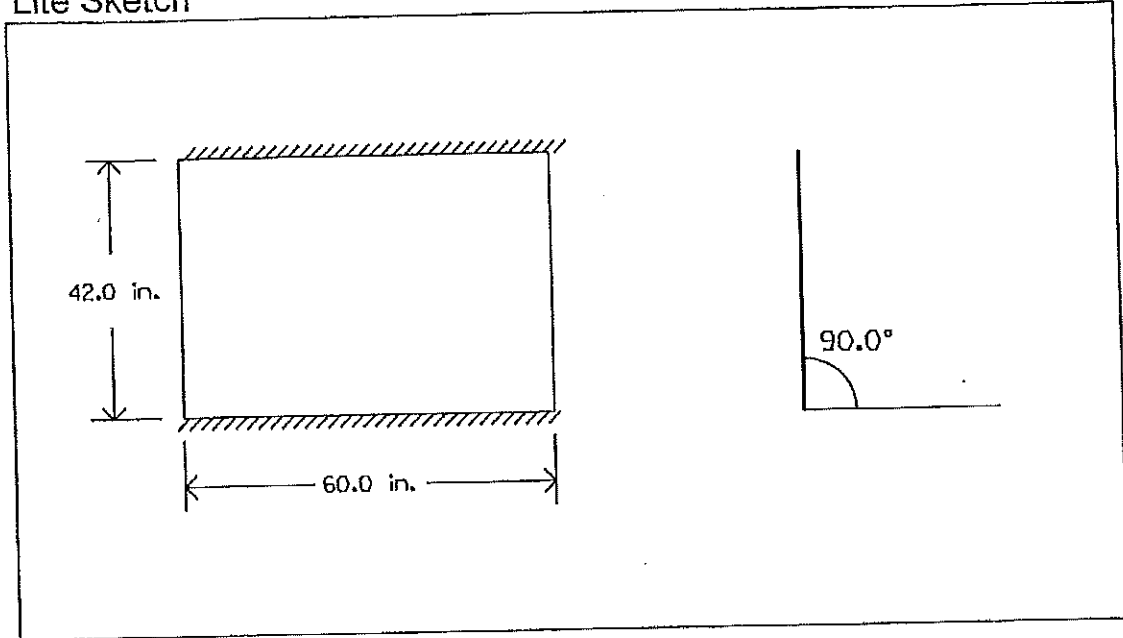

6.0 mm (1/4 in.) Glass

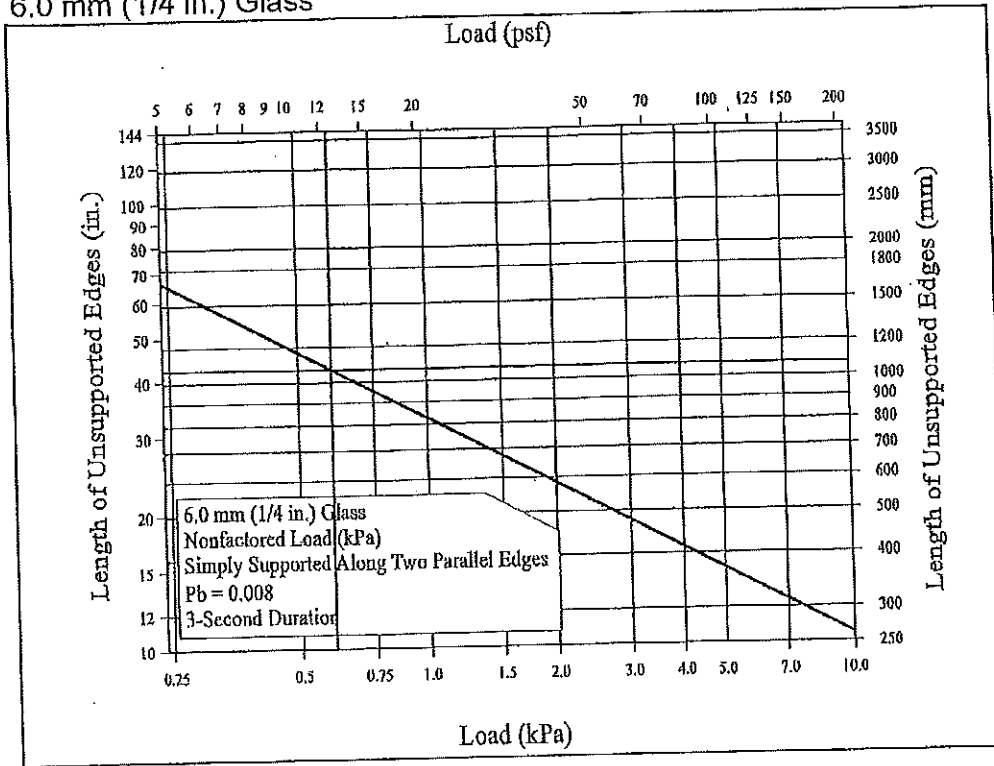

Short Duration Load
 Non-Factored Load: 12.5 psf
 Glass Type Factor: 4.00

Load Resistance: 50.1 psf
 Approximate Deflection: 0.96 in.

Long Duration Load
 Non-Factored Load: 12.5 psf
 Glass Type Factor: 3.00

Load Resistance: 37.5 psf
 Approximate Deflection: 0.41 in.

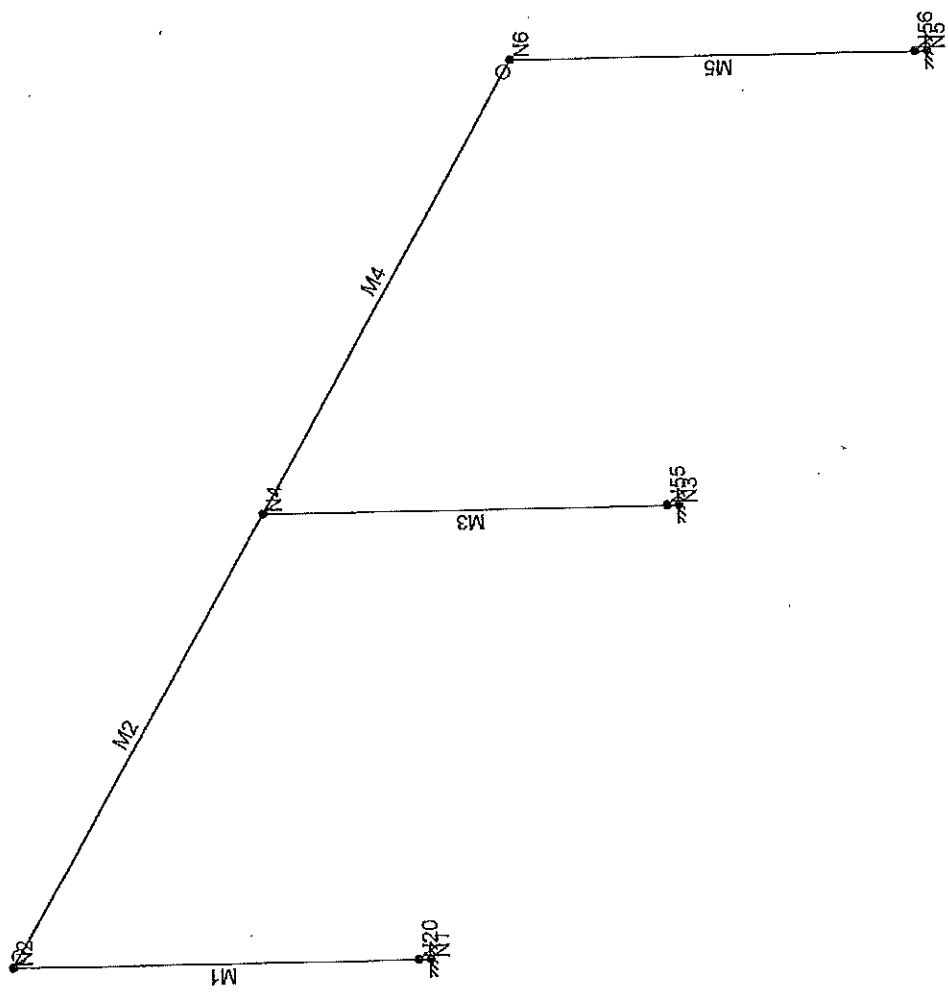
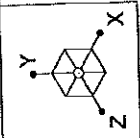

SK - 1	Glass W/ Clips
Sept 22, 2017 at 9:31 AM	
Glass w-clip.r3d	
PSEI	Eglass 217-2
AF	

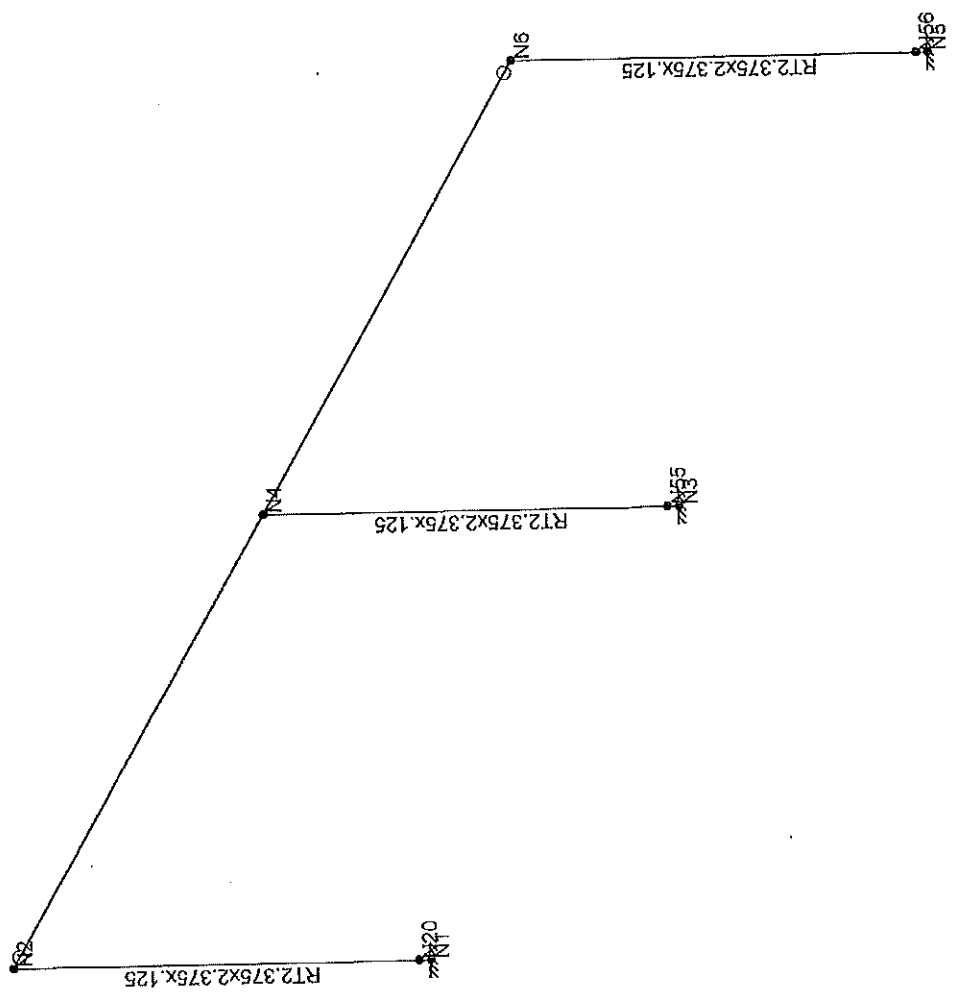
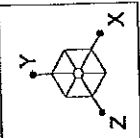

SK - 2
 Sept 22, 2017 at 9:31 AM
 Glass w-clip.r3d

Glass W/ Clips

PSEI
 AF
 Eglass 217-2

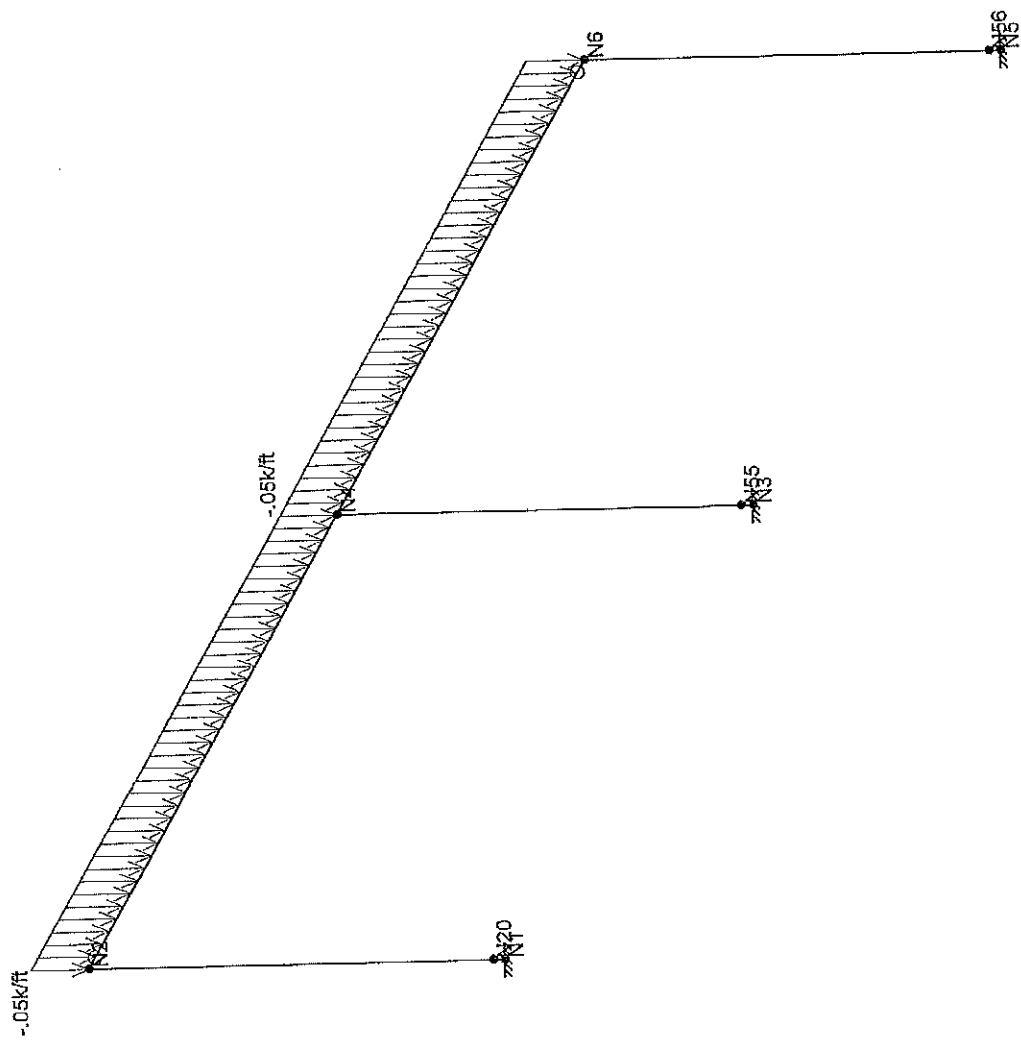
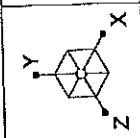

Loads: BLC 1, Distributed load-y at the top of

PSEI

AF

Eglass 217-2

SK - 3

Sept 22, 2017 at 9:31 AM

Glass w-clip.r3d

Glass W/ Clips

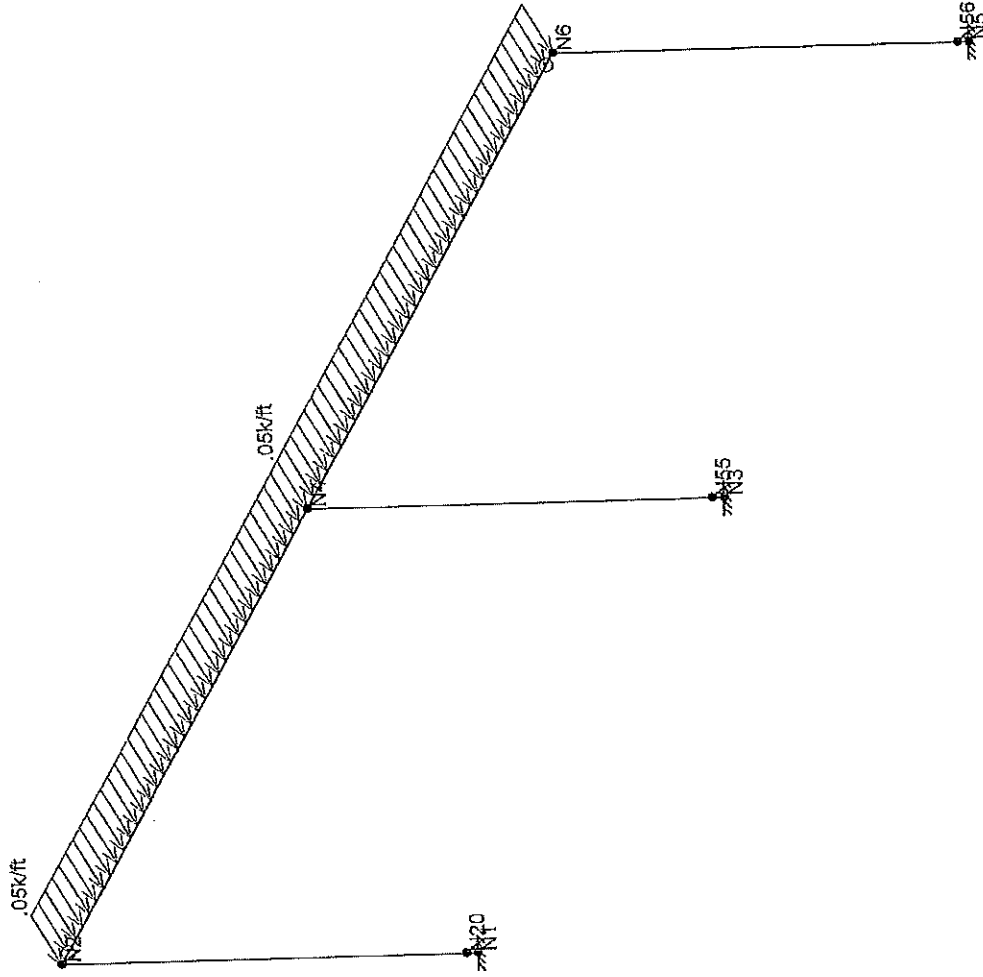
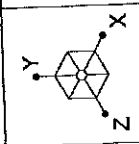

Loads: BLC 2, Distributed load-X at the side o

PSEI

AF

Eglass 217-2

SK - 4

Sept 22, 2017 at 9:31 AM

Glass w-clip.r3d

Glass W/ Clips

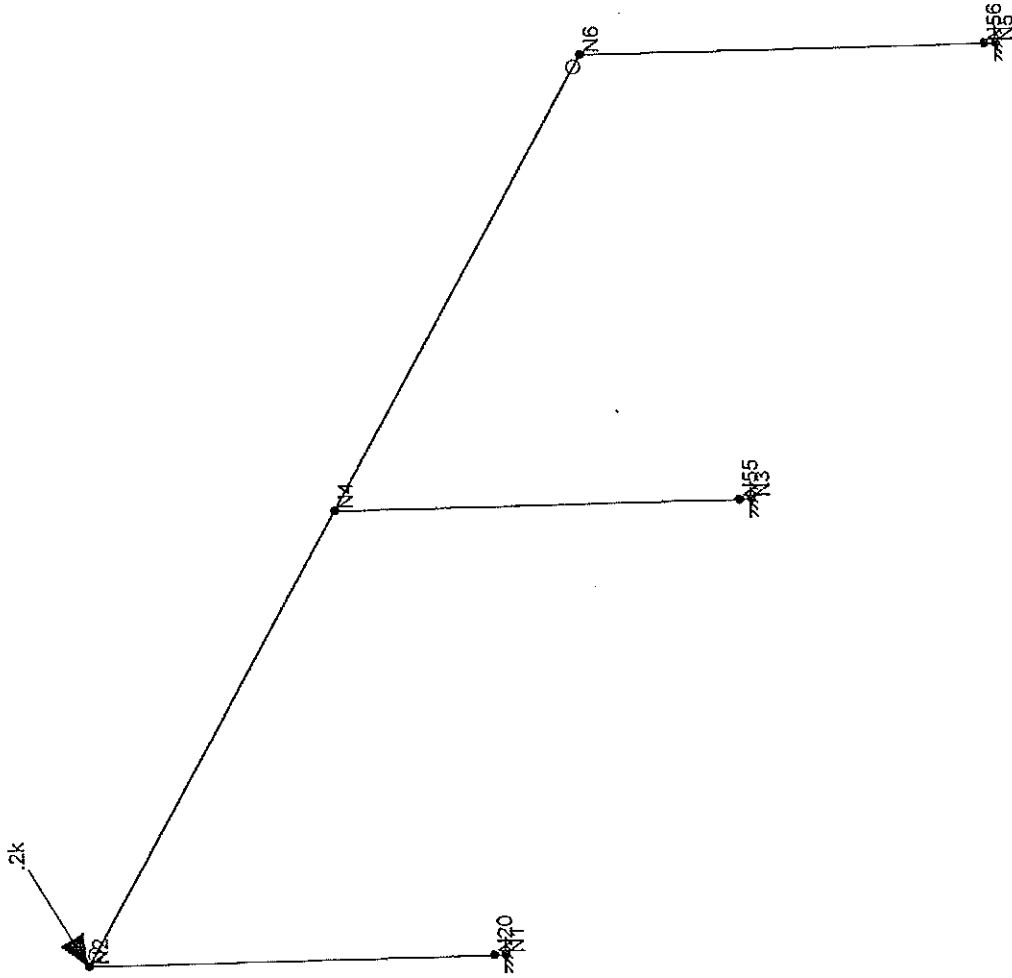
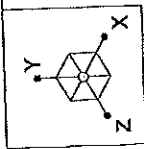

Loads: BLC 3, Point load applied at the corner

PSEI

AF

Eglass 217-2

Glass W/ Clips

SK - 5

Sept 22, 2017 at 9:31 AM

Class w-clip.r3d

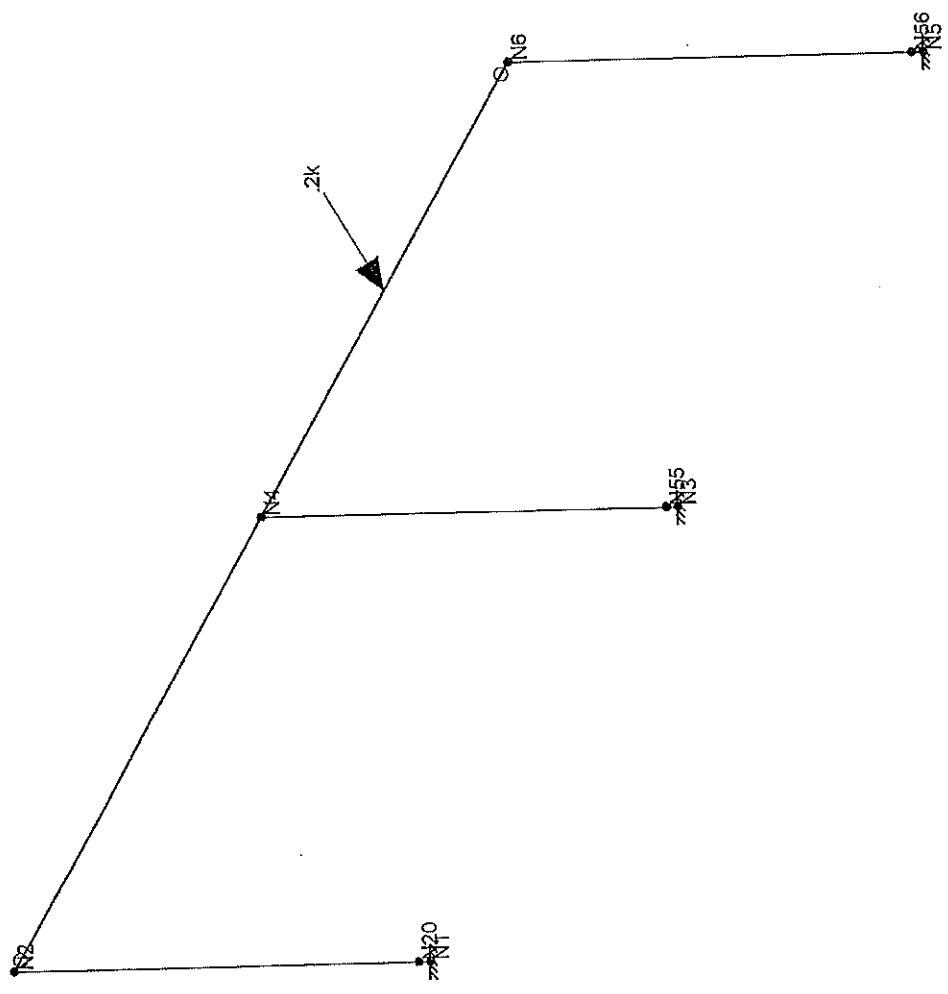
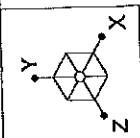

Loads: BLC 4, Point load applied at the middle

PSEI

AF

Eglass 217-2

SK - 6

Sept 22, 2017 at 9:31 AM

Glass w-clip.r3d

Glass W/ Clips

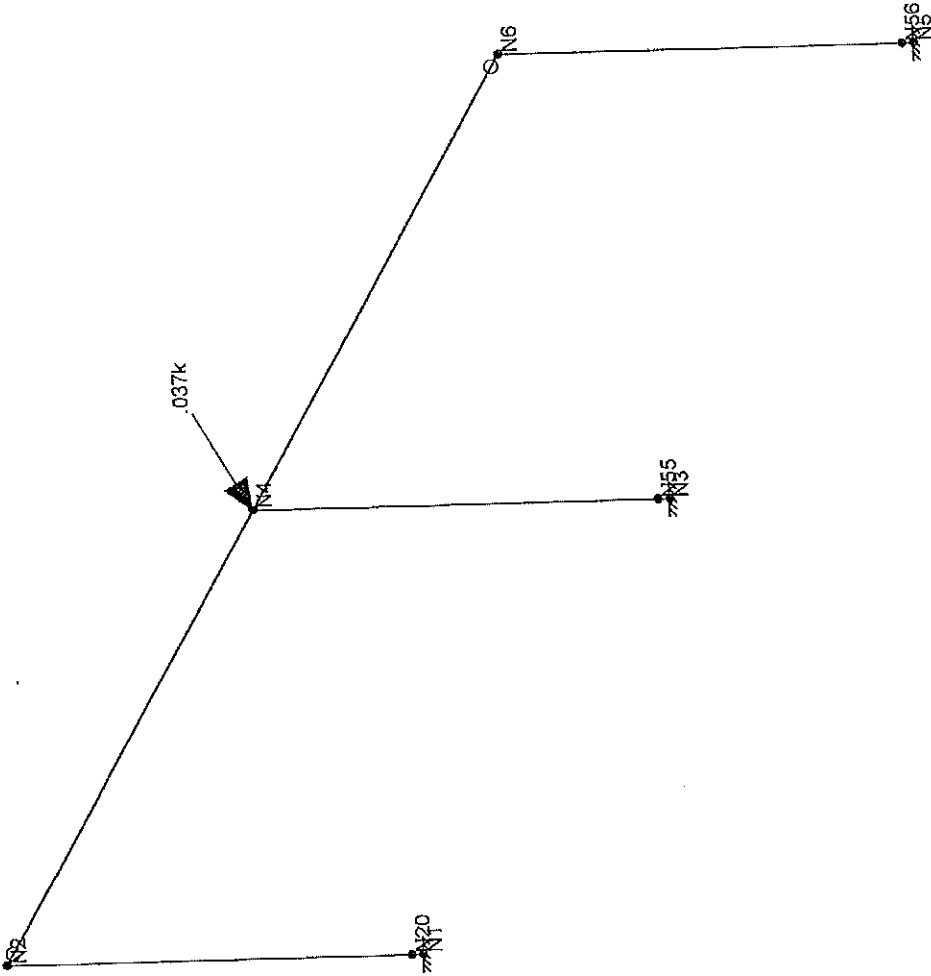
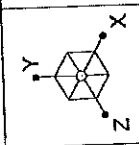

Loads: BLC 5, Infill

PSEI

AF

Eglass 217-2

SK - 7

Sept 22, 2017 at 9:31 AM

Glass w-clip.r3d

Glass W/ Clips

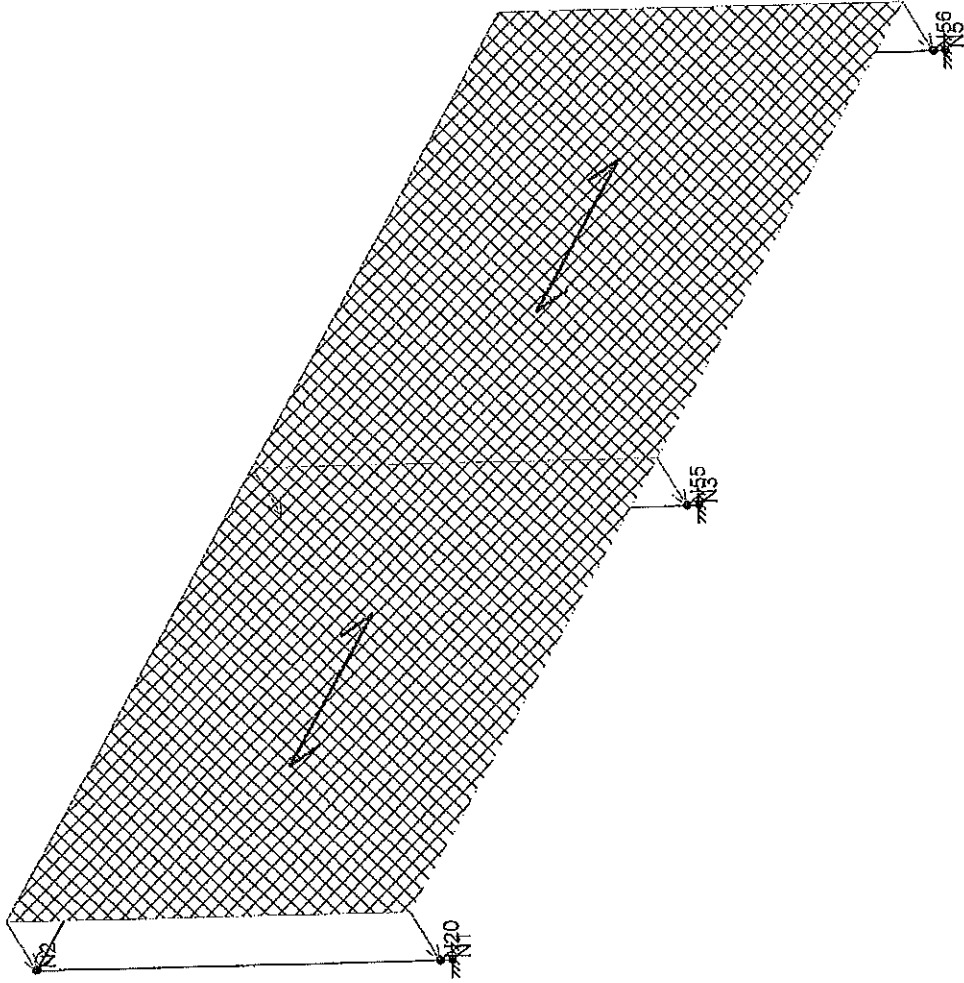
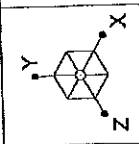

Loads: BLC 6, Wind

PSEI

AF

Eglass 217-2

SK - 8

Sept 22, 2017 at 9:31 AM

Glass w-clip.r3d

Glass W/ Clips

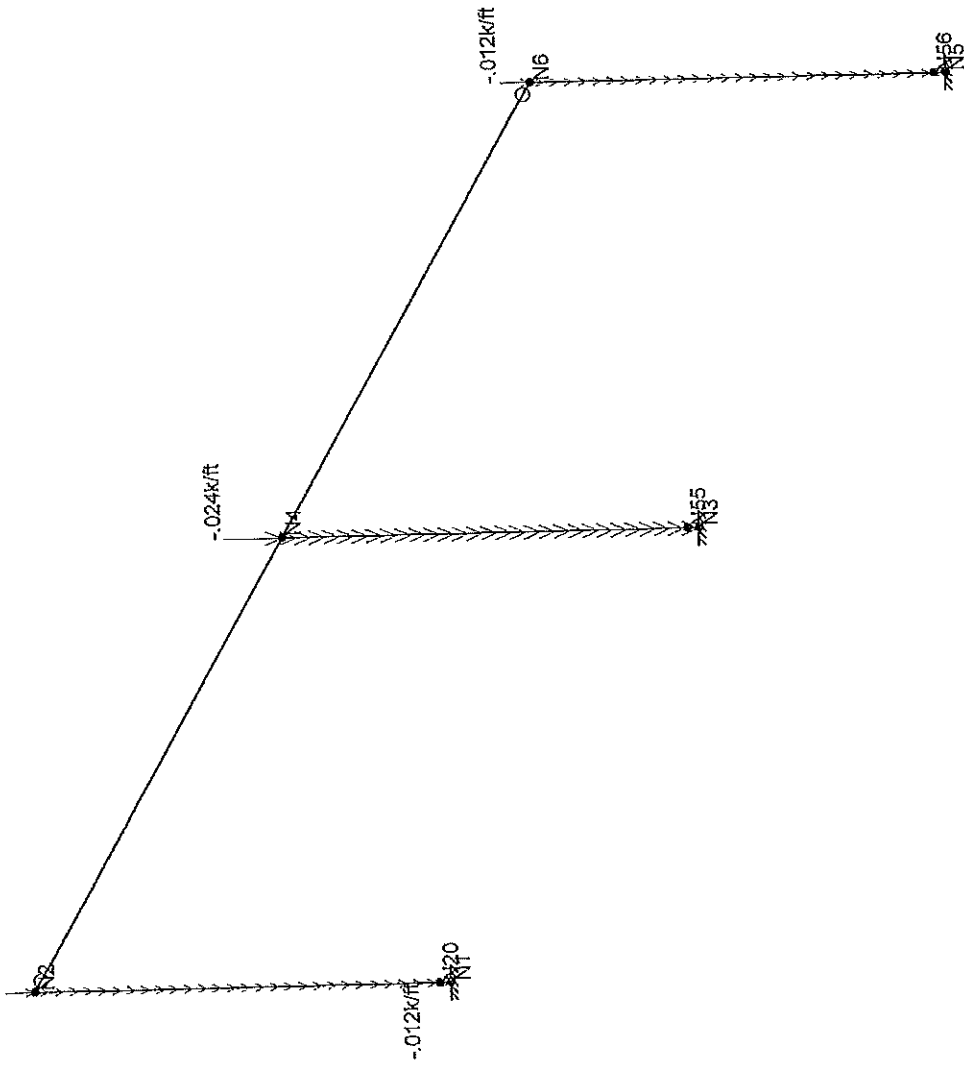
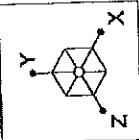

Loads: BLC 7, Glass weight

PSEI

AF

Eglass 217-2

SK - 9

Sept 22, 2017 at 9:31 AM

Glass w-clip.r3d

Glass W/ Clips



Company : PSEI
 Designer : AF
 Job Number : Eglass 217-2
 Model Name : Glass W/ Clips

Sept 22, 2017
 1:00 PM
 Checked By: _____

Hot Rolled Steel Properties

	Label	E [ksi]	G [ksi]	Nu	Therm (1/E... Density[k/ft...	Yield[ksi]	Ry	Fu[ksi]	Rt
1	A36 Gr.36	29000	11154	.3	.65	49	36	58	1.2
2	A572 Gr.50	29000	11154	.3	.65	49	50	65	1.1
3	A992	29000	11154	.3	.65	49	50	65	1.1
4	A500 Gr.42	29000	11154	.3	.65	49	42	58	1.3
5	A500 Gr.46	29000	11154	.3	.65	49	46	58	1.3
6	316SS	28000	10732	.3	.65	501	30	75	1.2

Aluminum Properties

	Label	E [ksi]	G [ksi]	Nu	Therm (... Density[...	Table B.4	kt	Ftu[ksi]	Fty[ksi]	Fcy[ksi]	Fsu[ksi]	Ct
1	3003-H14	10100	3787.5	.33	1.3	.173 Table B.4-1	1	19	16	13	12	141
2	6061-T6	10100	3787.5	.33	1.3	.173 Table B.4-2	1	38	35	35	24	141
3	6063-T5	10100	3787.5	.33	1.3	.173 Table B.4-2	1	22	16	16	13	141
4	6063-T6	10100	3787.5	.33	1.3	.173 Table B.4-2	1	30	25	25	19	141
5	5052-H34	10200	3787.5	.33	1.3	.173 Table B.4-1	1	34	26	24	20	141
6	6061-T6 W	10100	3787.5	.33	1.3	.173 Table B.4-1	1	24	15	15	15	141

Hot Rolled Steel Section Sets

	Label	Shape	Type	Design List	Material	Design R...	A [in ²]	Iyy [in ⁴]	Izz [in ⁴]	J [in ⁴]
1	CABLE	3/16" Rod	HBrace	None	A36 Gr.36	Typical	.027	6e-5	6e-5	.00012

Aluminum Section Sets

	Label	Shape	Type	Design List	Material	Design Rules	A [in ²]	Iyy [in ⁴]	Izz [in ⁴]	J [in ⁴]
1	POST	RT2.375x2.37...	Column	Rectangular Tubes	6061-T6	Typical	1.125	.952	.952	1.424
2	TOP RAIL	RT1X1X0.095	Beam	Rectangular Tubes	6061-T6	Typical	.344	.048	.048	.07
3	BOTTOM ...	RT1X1X0.095	Beam	Rectangular Tubes	6061-T6	Typical	.344	.048	.048	.07

Joint Coordinates and Temperatures

	Label	X [ft]	Y [ft]	Z [ft]	Temp [F]	Detach From Diap...
1	N1	0	0	0	0	
2	N2	0	4	0	0	
3	N3	5	0	0	0	
4	N4	5	4	0	0	
5	N5	10	0	0	0	
6	N6	10	4	0	0	
7	N20	0	0.1125	0	0	
8	N55	5	0.1125	0	0	
9	N56	10	0.1125	0	0	

Joint Boundary Conditions

	Joint Label	X [k/in]	Y [k/in]	Z [k/in]	X Rot.[k-ft/rad]	Y Rot.[k-ft/rad]	Z Rot.[k-ft/rad]
1	N1	Reaction	Reaction	Reaction	Reaction	Reaction	Reaction
2	N3	Reaction	Reaction	Reaction	Reaction	Reaction	Reaction
3	N5	Reaction	Reaction	Reaction	Reaction	Reaction	Reaction



Company : PSEI
 Designer : AF
 Job Number : Eglass 217-2
 Model Name : Glass W/ Clips

Sept 22, 2017
 1:00 PM
 Checked By: _____

Hot Rolled Steel Design Parameters

Label	Shape	Length(ft)	Lbyy(ft)	Lbzz(ft)	Lcomp top(ft)	Lcomp bot(ft)	L-torqu...	Kyy	Kzz	Cb	Function
No Data to Print ...											

Aluminum Design Parameters

Label	Shape	Length(ft)	Lbyy(ft)	Lbzz(ft)	Lcomp top(ft)	Lcomp bot(ft)	L-torqu...	Kyy	Kzz	Cb	Function
1	M1	POST	4		Lbyy						Lateral
2	M3	POST	4		Lbyy						Lateral
3	M5	POST	4		Lbyy						Lateral

Basic Load Cases

BLC Description	Category	X Gravity	Y Gravity	Z Gravity	Joint	Point	Distribut..	Area(M...	Surface...
1 Distributed load-y at the top of	None		-1				2		
2 Distributed load-X at the side o	None		-1				2		
3 Point load applied at the corner	None		-1		1				
4 Point load applied at the middle	None		-1			1			
5 Infill	None				1				
6 Wind	None							2	
7 Glass weight	None						3		
8 BLC 6 Transient Area Loads	None						4		

Load Combinations

Description So...	PDelta	S...	BLC Fact..	BLC Fact..	BLC Fact..	BLC Fact..	BLC Fact..	BLC Fact..	BLC Fact..	BLC Fact..	BLC Fact..	BLC Fact..
1 Distribute...	Yes	Y	1	1	7	1						
2 Distribute...	Yes	Y	2	1	7	1						
3 Point load..	Yes	Y	3	1	7	1						
4 Point load..	Yes	Y	4	1	7	1						
5 Infill	Yes	Y	5	1	7	1						
6 Wind	Yes	Y	6	1	7	1						

Load Combination Design

Description	ASIF	CD	ABIF	Service	Hot Rolled	Cold For...	Wood	Concrete	Masonry	Footings	Aluminum	Connecti...
1 Distributed l...					Yes	Yes	Yes	Yes	Yes	Yes	Yes	Yes
2 Distributed l...					Yes	Yes	Yes	Yes	Yes	Yes	Yes	Yes
3 Point load a...					Yes	Yes	Yes	Yes	Yes	Yes	Yes	Yes
4 Point load a...					Yes	Yes	Yes	Yes	Yes	Yes	Yes	Yes
5 Infill					Yes	Yes	Yes	Yes	Yes	Yes	Yes	Yes
6 Wind					Yes	Yes	Yes	Yes	Yes	Yes	Yes	Yes

Joint Loads and Enforced Displacements (BLC 3 : Point load applied at the corner)

Joint Label	L,D,M	Direction	Magnitude((k.k-ft), (in.rad), (k*s^2/ft...
1 N2	L	Z	.2

Joint Loads and Enforced Displacements (BLC 5 : Infill)

Joint Label	L,D,M	Direction	Magnitude((k.k-ft), (in.rad), (k*s^2/ft...
1 N4	L	Z	.037



Company : PSEI
 Designer : AF
 Job Number : Eglass 217-2
 Model Name : Glass W/ Clips

Sept 22, 2017
 1:00 PM
 Checked By: _____

Envelope Joint Reactions

Joint		X [k]	LC	Y [k]	LC	Z [k]	LC	MX [k-ft]	LC	MY [k-ft]	LC	MZ [k-ft]	LC	
1	N1	max	0	1	228	1	0	1	0	1	0	1	0	2
2		min	0	2	.056	5	-.353	6	-.795	6	0	1	0	1
3	N3	max	0	2	.252	1	0	1	0	1	.009	4	0	2
4		min	0	1	.08	5	-.499	6	-.898	6	-.019	3	0	1
5	N5	max	0	1	.228	1	.031	3	0	1	0	1	0	2
6		min	0	2	.056	5	-.353	6	-.795	6	0	1	0	1
7	Totals:	max	0	2	.708	1	0	1						
8		min	0	1	.192	5	-1.205	6						

Envelope Member Section Forces

Member	Sec		Axial[k]	LC	y Shear[k]	LC	z Shear[k]	LC	Torque[k-...]	LC	y-y Mome...	LC	z-z Mome...	LC
1	M1	1	max	.228	1	0	1	0	1	0	.795	6	0	1
2			min	.056	5	0	1	-.353	6	0	0	1	0	1
3		2	max	.215	1	0	1	0	1	0	.503	2	0	1
4			min	.044	5	0	1	-.285	6	0	0	1	0	1
5		3	max	.201	1	0	1	0	1	0	.335	2	0	1
6			min	.032	5	0	1	-.207	6	0	0	1	0	1
7		4	max	.188	1	0	1	0	1	0	.168	2	0	1
8			min	.02	5	0	1	-.168	2	0	-.031	3	0	1
9		5	max	.175	1	0	1	0	1	0	.098	4	0	1
10			min	-.008	2	0	1	-.168	2	0	-.197	3	0	1
11	M2	1	max	0	1	.035	3	-.008	2	.197	3	0	1	0
12			min	0	1	-.167	2	-.175	1	-.098	4	0	1	0
13		2	max	0	1	.035	3	-.008	2	.197	3	-.01	2	.169
14			min	0	1	-.104	2	-.112	1	-.098	4	-.179	1	-.044
15		3	max	0	1	.035	3	-.008	2	.197	3	-.02	2	.26
16			min	0	1	-.052	6	-.05	1	-.098	4	-.28	1	-.088
17		4	max	0	1	.035	3	.013	1	.197	3	-.03	2	.273
18			min	0	1	-.052	6	-.008	5	-.098	4	-.303	1	-.132
19		5	max	0	1	.083	2	.075	1	.197	3	-.04	2	.258
20			min	0	1	-.052	6	-.008	5	-.098	4	-.248	1	-.176
21	M3	1	max	.151	1	0	1	.103	6	.009	4	0	1	0
22			min	-.016	2	0	1	-.168	2	-.019	3	-.069	6	0
23		2	max	.176	1	0	1	0	1	.009	4	0	1	0
24			min	.008	5	0	1	-.168	2	-.019	3	-.168	2	0
25		3	max	.201	1	0	1	0	1	.009	4	0	1	0
26			min	.032	5	0	1	-.207	6	-.019	3	-.335	2	0
27		4	max	.227	1	0	1	0	1	.009	4	0	1	0
28			min	.056	5	0	1	-.362	6	-.019	3	-.503	2	0
29		5	max	.252	1	0	1	0	1	.009	4	0	1	0
30			min	.08	6	0	1	-.499	6	-.019	3	-.898	6	0
31	M4	1	max	0	1	.052	6	.008	5	.197	3	-.04	2	.258
32			min	0	1	-.084	4	-.075	1	-.098	4	-.248	1	-.157
33		2	max	0	1	.052	6	.008	5	.197	3	-.03	5	.273
34			min	0	1	-.084	4	-.013	1	-.098	4	-.303	1	-.118
35		3	max	0	1	.116	4	.05	1	.197	3	-.02	5	.289
36			min	0	1	-.031	3	.008	2	-.098	4	-.28	1	-.079
37		4	max	0	1	.116	4	.112	1	.197	3	-.01	5	.169
38			min	0	1	-.031	3	.008	2	-.098	4	-.179	1	-.039
39		5	max	0	1	.167	2	.175	1	.197	3	0	1	0
40			min	0	1	-.031	3	.008	2	-.098	4	0	1	0
41	M5	1	max	.175	1	0	1	.031	3	0	.098	4	0	1
42			min	.008	2	0	1	-.168	2	0	-.197	3	0	1
43		2	max	.188	1	0	1	.031	3	0	0	1	0	1



Company : PSEI
 Designer : AF
 Job Number : Eglass 217-2
 Model Name : Glass W/ Clips

Sept 22, 2017
 1:00 PM
 Checked By: _____

Envelope Member Section Forces (Continued)

Member	Sec		Axial[k]	LC	y Shear[k]	LC	z Shear[k]	LC	Torque[k]	LC	y-y Mome...	LC	z-z Mome...	LC
44		min	.02	5	0	1	-.168	2	0	1	-.168	2	0	1
45	3	max	.201	1	0	1	.031	3	0	1	0	1	0	1
46		min	.032	5	0	1	-.207	6	0	1	-.335	2	0	1
47	4	max	.215	1	0	1	.031	3	0	1	0	1	0	1
48		min	.044	5	0	1	-.285	6	0	1	-.503	2	0	1
49	5	max	.228	1	0	1	.031	3	0	1	0	1	0	1
50		min	.056	6	0	1	-.353	6	0	1	-.795	6	0	1

Envelope Member Section Deflections

Member	Sec		x [in]	LC	y [in]	LC	z [in]	LC	x Rotate [r...	LC	(n) L/y Ratio	LC	(n) L/z Ratio	LC
1	M1	1	max	0	1	0	0	1	0	1	NC	1	NC	1
2		min	0	1	0	0	0	1	0	1	NC	1	NC	1
3	2	max	0	5	0	1	.078	6	0	1	NC	1	NC	1
4		min	0	1	0	1	0	1	0	1	NC	1	616.893	6
5	3	max	0	5	0	1	.263	6	0	1	NC	1	NC	1
6		min	0	1	0	1	0	1	0	1	NC	1	182.57	6
7	4	max	0	5	0	1	.511	2	0	1	NC	1	NC	1
8		min	0	1	0	1	0	1	0	1	NC	1	93.893	2
9	5	max	0	5	0	1	.807	2	0	1	NC	1	NC	1
10		min	-.001	1	0	1	0	1	0	1	NC	1	59.472	2
11	M2	1	max	0	1	.807	2	.001	1	2.51e-02	2	NC	1	NC
12		min	0	1	0	1	0	5	0	1	NC	1	NC	1
13	2	max	0	1	.807	2	.001	1	2.51e-02	2	NC	1	NC	1
14		min	0	1	0	1	0	5	0	1	NC	1	NC	1
15	3	max	0	1	.807	2	.001	1	2.51e-02	2	NC	1	NC	1
16		min	0	1	0	1	0	5	0	1	NC	1	NC	1
17	4	max	0	1	.807	2	.001	1	2.51e-02	2	NC	1	NC	1
18		min	0	1	0	1	0	5	0	1	NC	1	NC	1
19	5	max	0	1	.807	2	.001	1	2.51e-02	2	NC	1	NC	1
20		min	0	1	0	1	0	5	0	1	NC	1	NC	1
21	M3	1	max	.001	1	0	1	0	1	1.001e-03	4	NC	1	NC
22		min	0	5	0	1	-.807	2	2.001e-03	3	NC	1	59.472	2
23	2	max	0	1	0	1	0	1	7.505e-04	4	NC	1	NC	1
24		min	0	5	0	1	-.511	2	1.501e-03	3	NC	1	93.893	2
25	3	max	0	1	0	1	0	1	5.003e-04	4	NC	1	NC	1
26		min	0	5	0	1	-.275	6	1.001e-03	3	NC	1	174.822	6
27	4	max	0	1	0	1	0	1	2.502e-04	4	NC	1	NC	1
28		min	0	5	0	1	-.084	6	5.003e-04	3	NC	1	568.647	6
29	5	max	0	1	0	1	0	1	0	1	NC	1	NC	1
30		min	0	1	0	1	0	1	0	1	NC	1	NC	1
31	M4	1	max	0	1	.807	2	.001	1	2.51e-02	2	NC	1	NC
32		min	0	1	0	1	0	5	0	1	NC	1	NC	1
33	2	max	0	1	.807	2	.001	1	2.51e-02	2	NC	1	NC	1
34		min	0	1	0	1	0	5	0	1	NC	1	NC	1
35	3	max	0	1	.807	2	.001	1	2.51e-02	2	NC	1	NC	1
36		min	0	1	0	1	0	5	0	1	NC	1	NC	1
37	4	max	0	1	.807	2	.001	1	2.51e-02	2	NC	1	NC	1
38		min	0	1	0	1	0	5	0	1	NC	1	NC	1
39	5	max	0	1	.807	2	.001	1	2.51e-02	2	NC	1	NC	1
40		min	0	1	0	1	0	5	0	1	NC	1	NC	1
41	M5	1	max	.001	1	0	1	0	1	0	1	NC	1	59.472
42		min	0	5	0	1	-.807	2	0	1	NC	1	NC	1
43	2	max	0	1	0	1	0	1	0	1	NC	1	93.893	2
44		min	0	5	0	1	-.511	2	0	1	NC	1	NC	1
45	3	max	0	1	0	1	0	1	0	1	NC	1	NC	1



Company : PSEI
 Designer : AF
 Job Number : Eglass 217-2
 Model Name : Glass W/ Clips

Sept 22, 2017
 1:00 PM
 Checked By: _____

Envelope Member Section Deflections (Continued)

Member	Sec		x [in]	LC	v [in]	LC	z [in]	LC	x Rotate [r...]	LC	(n) L/y Ratio	LC	(n) L/z Ratio	LC
46		min	0	5	0	1	-263	6	0	1	NC	1	182.57	6
47	4	max	0	1	0	1	0	1	0	1	NC	1	NC	1
48		min	0	5	0	1	-078	6	0	1	NC	1	616.893	6
49	5	max	0	1	0	1	0	1	0	1	NC	1	NC	1
50		min	0	1	0	1	0	1	0	1	NC	1	NC	1

Envelope AA ADM1-10: ASD - Building Aluminum Code Checks

Member	Shape	Code C...	Loc(ft)	LC	Shear...	Loc(ft)	Dir	LC	Pnc/O...	Pnt/Om...	Mny/O...	Mnz/O...	Vny/O...	Vnz/O...	Cb	Eqn
1	M1	RT2.375x...	.561	0	6	.055	0	z	6	15.383	21.923	1.417	1.417	6.364	6.364	1 H.1-1
2	M3	RT2.375x...	.633	4	6	.078	3.917	z	6	15.383	21.923	1.417	1.417	6.364	6.364	1 H.1-1
3	M5	RT2.375x...	.561	4	6	.055	3.917	z	6	15.383	21.923	1.417	1.417	6.364	6.364	1 H.1-1

Glass Load Resistance Report --

Friday, September 22, 2017

Glazing Information

Edge Supports: 2 Sides
Glazing Angle: 90°
Lite Dimensions:
 Unsupported Length: 42.0 in.
 Supported Length: 60.0 in.

Project Details

Project Name:
Location:
Comments:

Glass Construction (Rectangular)

Single Glazed Lite

Glass Type: Fully Tempered
Nominal Thickness: 1/4 in.

Short Load Duration, Resistance, and Deflection Data

Load (~ 3 sec.): 31.0 psf
Load Resistance: 50.1 psf
Approximate center of glass deflection: 0.96 in.

Long Load Duration, Resistance, and Deflection Data

Load (~ 30 days): 13.2 psf
Load Resistance: 37.5 psf
Approximate center of glass deflection: 0.41 in.

Conclusion

Based on your design information, the load resistance is greater than or equal to the specified loading.

Statement of Compliance

Procedures followed in determining the resistance of this window glass are in accordance with ASTM E1300-09/12.

Disclaimer:

This software can be used to determine the load resistance of specified glass types exposed to uniform lateral loads of short or long duration subject to the following conditions:

- The glass is free of edge and surface damage and has been properly glazed in the opening in conformance with the manufacturer's recommendations.
 - Procedures exist to determine load resistance for rectangular glass assemblies that are:
 - a. Continuously supported along all four edges,
 - b. Continuously supported along three edges,
 - c. Continuously supported along two parallel edges, and
 - d. Continuously supported along one edge.
 - The software user has the responsibility of selecting the correct procedures for the required application from the software.
 - The stiffness of members supporting any glass edge shall be sufficient that under design load, edge deflections shall not exceed $L/175$, where L denotes that length of the supported edge.
 - The manufacturer states that the Safety Plus II 0.090 Polyurethane Large Missile Resistant interlayer is comparable to the PVB interlayer.
- For other fining conditions that may apply, refer to Section 5 of ASTM E1300 and local building codes.

Neither SDG nor GANA guarantees and each disclaims any responsibility for any particular results relating to the use of the Window Glass Design 5 Software Program. SDG and GANA disclaim any liability for any personal injury or any loss or damage of any kind, including all indirect, special, or consequential damages and lost profits, arising out of or relating to the use of the Window Glass Design 5 Software Program.

Prepared by: _____ on 4/5/2017

Lite Sketch

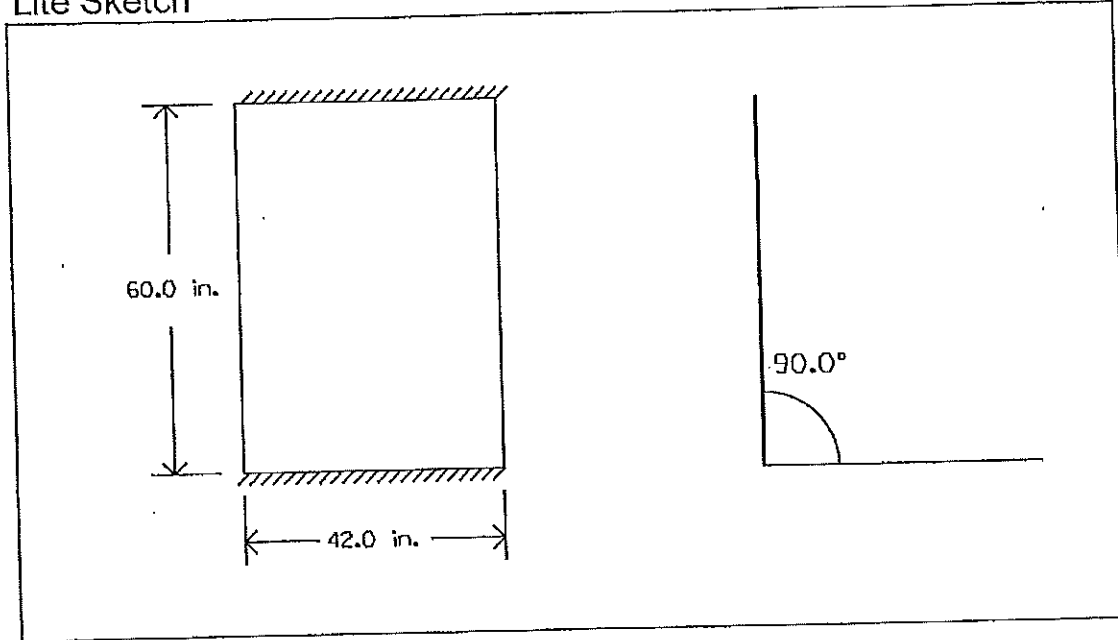

8.0 mm (5/16 in.) Glass

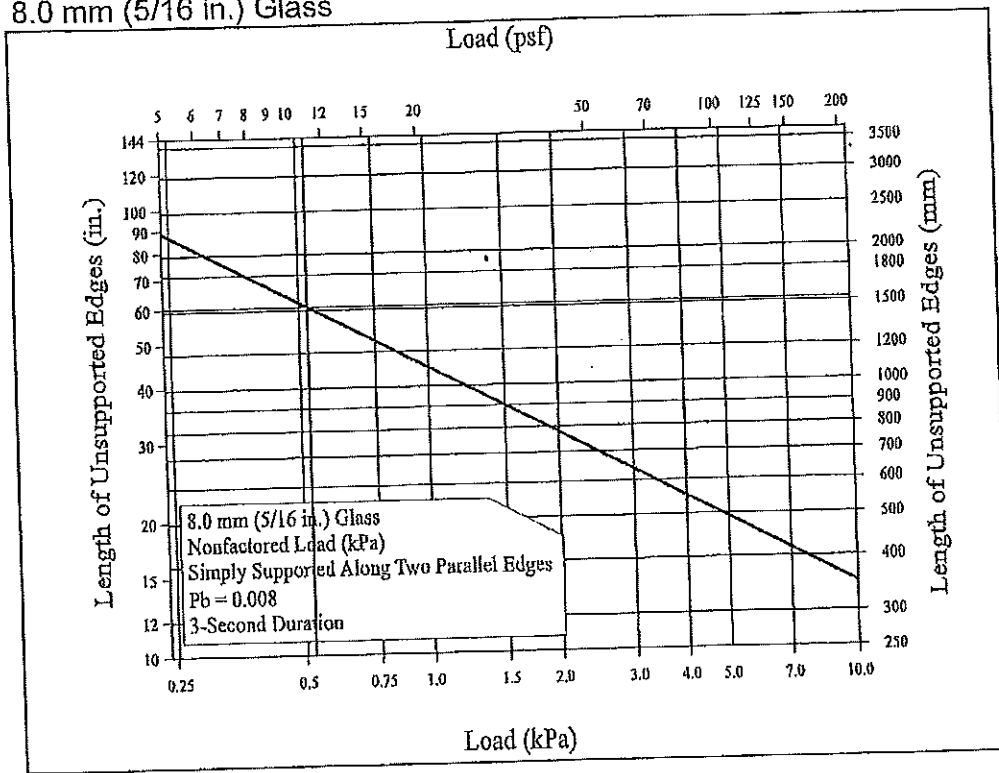

Short Duration Load
 Non-Factored Load: 10.9 psf
 Glass Type Factor: 4.00
 Load Resistance: 43.7 psf

 Approximate Deflection: 1.68 in.

Long Duration Load
 Non-Factored Load: 10.9 psf
 Glass Type Factor: 3.00
 Load Resistance: 32.8 psf

 Approximate Deflection: 0.72 in.

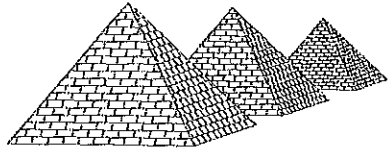

**Precision
Structural
Engineering, Inc.**

DECK AND FASCIA MOUNT ANALYSIS & DESIGN:

Pages 2,000 - 2,999



Anchorage Design - Deck Mount

Project Number	<u>Eglass 217-2</u>	Sheet	<u> </u>	Date	<u>9/19/2017</u>
Project Name	<u> </u>	Designed by	<u>IE</u>	Date	<u> </u>
Subject	<u> </u>	Checked by	<u> </u>	Date	<u> </u>

Base Plate Design

	Input
	Calculated

Try 4-1/4" x 4-1/4" ADC12

Max shear force, P =  354.00 lb

Plate Thickness, $t \geq \ell \sqrt{3.33 P / (F_y \cdot B \cdot N)}$

ℓ	=	 1.00 in
B	=	 4.25 in
N	=	 4.25 in
f_y	=	 24 ksi

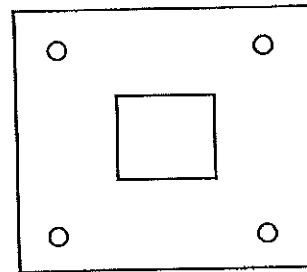

Plate Thickness, $t \geq$  0.043 in

Try [4-1/2" x 4-1/2" x 3/8" , Aluminum Alloy 384 (ADC)

$F_y = 24$ Ksi

Base Plate To Concrete

Use ITW Red Head Turbolt Wedge

Anchor strength based on ESR-2427

Concrete Capacity, f_c	=	3,000	psi
Bolt size	=	3/8	in
Bolt Spacing, S	=	3.50	in
Plate Edge distance, e	=	0.5	in
Concrete Edge distance, C_a	=	3.25	in
Max Shear force, P	=	250	lb, as per Risa Output
Max Moment, M	=	700	lb-ft, (200 lb * 3.5' or 50(pif) * 4' * 3.5
Effective depth, h_{eff}	=	4	in
Tension/ 2 bolts	=	2100	lb
Shear/ 2 bolts	=	250.0	lb

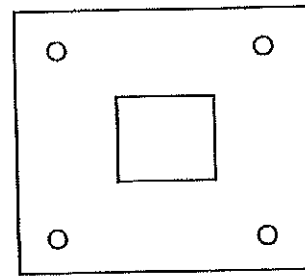

post height ↴

post spacing ↴

Check of Concrete Breakout Strength

$$N_{cbg} = (A_{Nc} / A_{Nco}) * \Psi_{ed,N} \Psi_{ed,N} \Psi_{c,N} \Psi_{cp,N} N_b$$

$A_{Nc} = (C_a + S + 1.5h_{eff})^2$	=	162.6 in ²
$A_{Nco} = 9h_{eff}^2$	=	144.0 in ²
$\Psi_{ec,N} = 1 / [1 + (2*S/2)/3h_{eff}]$	=	0.77
$\Psi_{ed,N} = 0.7 + 0.3 * [C_a / (1.5 h_{eff})]$	=	0.86
$\Psi_{c,N}$	=	1.40
$\Psi_{cp,N}$	=	1.0
$N_b = 17 \lambda f_c^{1/2} (h_{eff})^{1.5}$	=	7,449 lb
N_{cbg}	=	7,861.3 lb
Capacity of (2) 3/8" Wedge	=	8,400.0 lb
Allowable tension Load capacity =		3,193.6 lb

2100 lb	<	3,193.6 lb
SAFE		

USE [1/2" ϕ Lag Screws @ 32" o.c., Min 3" Embedment into wood blocking]

Check of Concrete Breakout Strength

$$V_{cbg} = (A_{Vc} / A_{Vco}) * \Psi_{ec} \Psi_{ed} \Psi_c \Psi_h V_b$$

$A_{Vc} = [2(1.5C_a) + S] h_{eff}$	=	53.0 in ²
$A_{Vco} = 4.5C_a^2$	=	47.5 in ²
$\Psi_{ec} = 1 / [1 + (2*S/2)/3C_a]$	=	0.74
$\Psi_{ed} = 0.7 + 0.3 * [C_a / (1.5 C_a)]$	=	0.90
Ψ_c	=	1.00
$\Psi_h = (1.5 C_a / h_{eff})^{1/2}$	=	1.10
$V_b = 8 (h_{eff}/\phi)^{0.2} (\phi)^{0.5} \lambda (f'_c)^{0.5} 0.5 C_a^{1.5}$	=	2,524
V_{cb}	=	2,057.7 lb
Capacity of (2) 3/8" Wedge	=	3,660.0 lb
Allowable Shear Load capacity =	=	900.2 lb

250.0 lb	<	900.2 lb
SAFE		

Tension - Shear Interaction

Shear force, P = 250 lb, as per Risa Output
Moment, M = 942 lb-ft, as per Risa Output
Tension, T = 2,100 lb

$$\frac{T}{\phi N_{cbg}} + \frac{P}{V_{cbg}} < 1.2$$
$$\frac{T}{\phi N_{cbg}} + \frac{P}{V_{cbg}} = 1.16 < 1.2$$

SAFE



PROJECT NO. Eg1085 217-2 SHEET 2004A OF _____
PROJECT NAME _____ DESIGNED BY AF DATE _____
SUBJECT _____ CHECKED BY _____ DATE _____

Base plate to wood

wood specific weight = 0.43

$$Tension = \frac{M}{d} = \frac{200 \times \frac{42''}{12} \times 12 \frac{\text{in}}{\text{ft}}}{4''} = 2,100 \text{ lb}$$

Adjustment for wood bearing

$$C_b = (4.5'' + 0.375) / 4.5'' = 1.083$$

$$a = \frac{2100 \text{ lb}}{1.083 \times 625 \text{ psi} \times 4.5} = 0.69$$

$$Tension = T = \frac{700 \text{ lb/ft} \times \frac{12 \text{ in}}{\text{ft}}}{(4.5'' - \frac{0.69}{2})} = 2,298 \text{ lb}$$

$\frac{3}{8}'' \phi$ lag-screw w/ 6'' min Embed tension

$$Capacity = 314 \text{ lb} \times 4'' = 1256 \text{ lb} \quad (\text{page})$$

$$2 \text{-lag screws Capacity} = 2 \times 1256 = 2512 \text{ lb}$$

> 2298 lb

use [4 - $\frac{3}{8}''$ lag screws w/ 4'' min Embed]

Precision Structural Engineering, Inc.
250 Main Street, Suite A • Klamath Falls, OR 97601
Tel (541) 850-6300 • FAX (541) 850-6233

Medford Office
836 Mason Way (off Sage Road) • Medford, OR 97501
Tel (541) 858-8500

www.structure1.com • Email: info@structure1.com



PROJECT NO. Eglass 217-2 SHEET 2004 BOF
PROJECT NAME _____ DESIGNED BY AF DATE _____
SUBJECT _____ CHECKED BY _____ DATE _____

Base plate to wood

P = 2298 lb

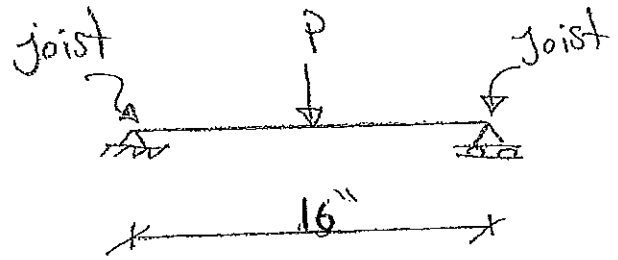

use blocking [3 - 2x8 w/ 4 - $\frac{5}{8}$ " ϕ lag screw]
w/ Min. 4" Embed



WoodWorks[®]
SOFTWARE FOR WOOD DESIGN

COMPANY

May 15, 2020 10:26

PROJECT

Stainless cable & Railing 217-1
AF
2020-05-14 wood block.wwb

Design Check Calculation Sheet
WoodWorks Sizer 11.1

Loads:

Load	Type	Distribution	Pat-tern	Location [ft]		Magnitude		Unit
				Start	End	Start	End	
Load1	Dead	Point		0.83		-2479		lbs
Self-weight	Dead	Full UDL				7.7		plf

Maximum Reactions (lbs), Bearing Capacities (lbs) and Bearing Lengths (in) :

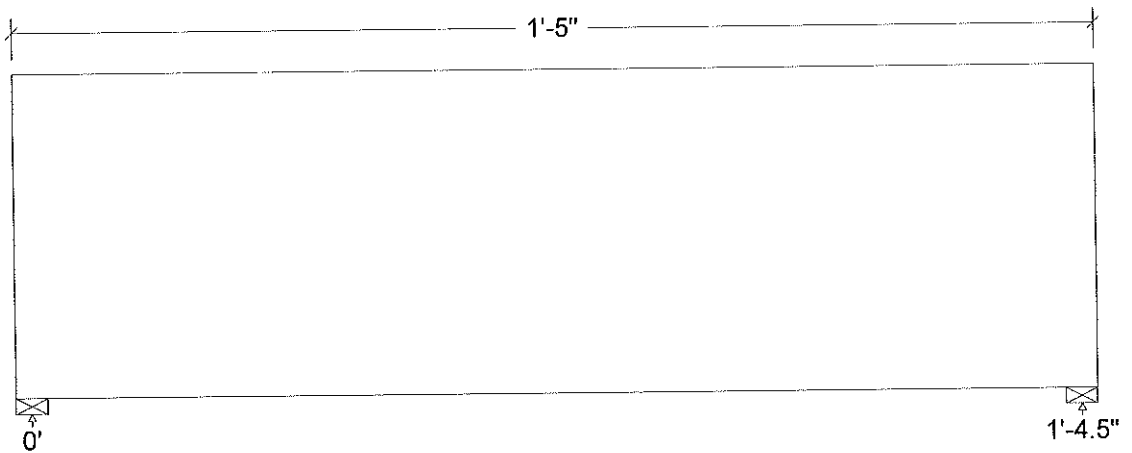

Unfactored:			
Dead	5		5
Factored:			
Uplift	-1009		-1460
Total	5		5
Bearing:			
Capacity			
Beam	2266		2266
Support	2266		2266
Des ratio			
Beam	0.00		0.00
Support	0.00		0.00
Load comb	#1		#1
Length	0.50*		0.50*
Min req'd	0.50*		0.50*
Cb	1.00		1.00
Cb min	1.00		1.00
Cb support	1.00		1.00
Fcp sup	625		625

*Minimum bearing length setting used: 1/2" for end supports

Lumber n-ply, D.Fir-L, No.2, 2x8, 3-ply (4-1/2"x7-1/4")

Supports: All - Timber-soft Beam, D.Fir-L No.2

Total length: 1'-5.0"; Clear span: 1'-4.0"; volume = 0.3 cu.ft.

Lateral support: top= at supports, bottom= at supports; Oblique angle: 90.0 deg; Repetitive factor: applied where permitted (refer to online help);

Analysis vs. Allowable Stress and Deflection using NDS 2015 :

Criterion	Analysis Value	Design Value	Unit	Analysis/Design
Shear x-x	fv = 0	Fv' = 162	psi	fv/Fv' = 0.00
y-y	fv = 67	Fv' = 162	psi	fv/Fv' = 0.42
Bending(-) x-x	fb = 0	Fb' = 1118	kip-ft	fb/Fb' = 0.00
y-y	fb = 1210	Fb' = 1285	kip-ft	fb/Fb' = 0.94
Live Defl'n	negligible			
Total Defl'n	-0.03 = L/486	0.07 = L/240	in	0.49

Additional Data:

FACTORS:	F/E (psi)	CD	CM	Ct	CL	CF	Cfu	Cr	Cf _{rt}	C _i	C _n	LC#
F _{vy} '	180	0.90	1.00	1.00	-	-	-	-	1.00	1.00	-	1
F _{by} '	900	0.90	1.00	1.00	1.000	1.200	1.15	1.15	1.00	1.00	-	1
F _{cp} '	625	-	1.00	1.00	-	-	-	-	1.00	1.00	-	-
E'	1.6 million		1.00	1.00	-	-	-	-	1.00	1.00	-	1
E _{min} '	0.58 million		1.00	1.00	-	-	-	-	1.00	1.00	-	1

CRITICAL LOAD COMBINATIONS:

Shear : LC #1 = D only, V max = 1464, V design = 1464 lbs

Bending(-): LC #1 = D only, M = 822 lbs-ft

Deflection: LC #1 = D only (total)

D=dead L=live S=snow W=wind I=impact Lr=roof live Lc=concentrated E=earthquake

All LC's are listed in the Analysis output

Load combinations: ASCE 7-10 / IBC 2015

CALCULATIONS:

Deflection: EI_y = 9.79e06 lb-in²

"Live" deflection = Deflection from all non-dead loads (live, wind, snow...)

Total Deflection = 1.50(Dead Load Deflection) + Live Load Deflection.

Lateral stability(-): b = full member width

Design Notes:

- WoodWorks analysis and design are in accordance with the ICC International Building Code (IBC 2015), the National Design Specification (NDS 2015), and NDS Design Supplement.
- Please verify that the default deflection limits are appropriate for your application.
- Sawn lumber bending members shall be laterally supported according to the provisions of NDS Clause 4.4.1.
- BUILT-UP BEAMS:** it is assumed that each ply is a single continuous member (that is, no butt joints are present) fastened together securely at intervals not exceeding 4 times the depth and that each ply is equally top-loaded. Where beams are side-loaded, special fastening details may be required.
- FIRE RATING:** Joists, wall studs, and multi-ply members are not rated for fire endurance.

Precision Structural Engineering, Inc.
 250 Main Street, Suite A • Klamath Falls, OR 97601
 Tel (541) 860-6300 • FAX (541) 860-6233

Medford Office
 836 Mason Way (off Sage Road) • Medford, OR 97501
 Tel (541) 858-8500

www.structure1.com • Email: info@structure1.com



PROJECT NO. Egless 217-2 SHEET 2004 E OF
 PROJECT NAME _____ DESIGNED BY AF DATE _____
 SUBJECT Fascia mount CHECKED BY _____ DATE _____

post is directly attached with no bracket

* with concrete

$\frac{3}{8}$ " ϕ red head ITW

Allowable Tension load / bolt =

$$0.65 \times \frac{42000 \text{ lb}}{1.6}$$

$$= 1706 \text{ lb}$$

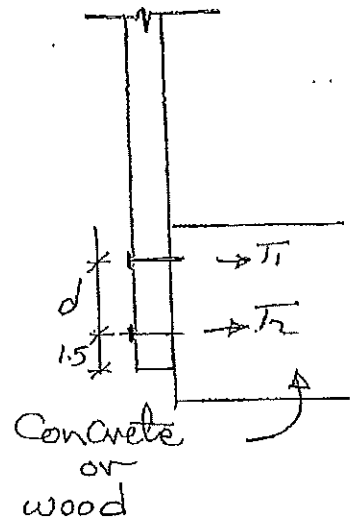

Applied Tension = $\frac{M}{d}$ $\hookrightarrow M = 200 \text{ lb} \times 4' = 800 \text{ lb-ft}$

of bolts to resist = 1.0

$$\frac{M}{d} \neq 1706 \text{ lb}$$

$$\frac{800 \text{ (lb-ft)} \times 12}{d} = 1,706 \text{ lb}$$

$$d = 5.62''$$

∴ spacing between anchors is 7"

Precision Structural Engineering, Inc.
250 Main Street, Suite A • Klamath Falls, OR 97601
Tel (541) 850-6300 • FAX (541) 850-6233

Medford Office
836 Mason Way (off Sage Road) • Medford, OR 97501
Tel (541) 858-8500

www.structure1.com • Email: info@structure1.com



PROJECT NO. Eglass 217-2 SHEET 2004F OF _____
PROJECT NAME _____ DESIGNED BY AF DATE _____
SUBJECT fascia Mount CHECKED BY _____ DATE _____

o₂ use [2 - $\frac{3}{8}$ " red head ITW or LDT
7" apart w/min 4" Embed.
post to extend 2.5" below bottom anchor
fc \geq 2500 psi, Concrete member
thickness \geq 3"]



PROJECT NO. EGLASS 2A-2 SHEET 2 OF 6
 PROJECT NAME _____ DESIGNED BY AF DATE _____
 SUBJECT Fascia Mount CHECKED BY _____ DATE _____

* with wood

$d = 7''$ (spacing between lag screws)

M₀ bottom of post = 800 lb-ft

Resisting moment = $T_1 \times 1.5 + T_2 \times 8.5$

$$T_1 = \frac{T_2 \times 1.5}{8.5}$$

$$\circ \circ \text{ Resisting moment} = 1.5 \times \frac{1.5}{8.5} \times T_2 + 8.5 T_2$$

$$= 8.76 T_1 \text{ (in. load)}$$

for equilibrium = $M = \text{resisting moment}$

$$800 \text{ (lb-ft)} \times 12 = 8.76 T_1$$

$$\circ \circ T_1 = 1,096 \text{ lb}$$

$$\circ \circ \text{ Embed. length} = \frac{T}{\text{with drawl capacity}}$$

$$\text{with drawl capacity} \rightarrow \frac{1096 \text{ lb}}{305} = 3.6''$$

(page 2026)

$\circ \circ$ use $2 - \frac{3}{8}'' \phi$ lag screws, 7" apart w/min 4" Emb.

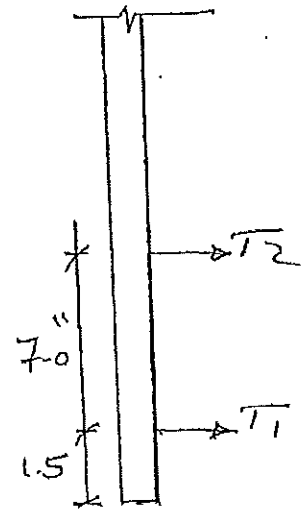



PROJECT NO. Eglass 217 - SHEET 2005 OF _____
 PROJECT NAME 42" post DESIGNED BY AF DATE _____
 SUBJECT _____ CHECKED BY _____ DATE _____

Fascia mount bracket

post = $2 \frac{3}{8} \times 2 \frac{3}{8} \times 0.125$ (42" height, 5' apart)

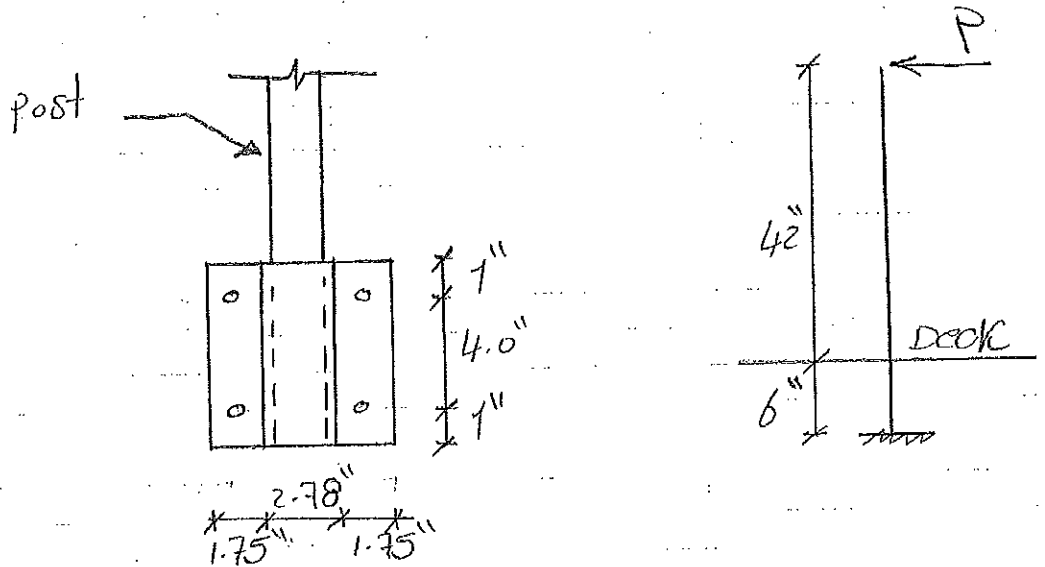

$P = 50 \text{ (lb/ft)} \times 5 \text{ (spacing)} = 250 \text{ lb}$

$M = 200 \text{ (lb)} \times (42 + 6) = 800 \text{ lb-ft}$

Max tension = $\frac{800}{\frac{(4+1)}{12}} = 1,920 \text{ lb}$

Shear on bolts = 441 lb

use [2 - #10 Tek screws to hold post in place]



PROJECT NO. _____ SHEET _____ OF _____
PROJECT NAME _____ DESIGNED BY _____ DATE _____
SUBJECT _____ CHECKED BY _____ DATE _____

Bracket Design

Material: Aluminum 606

Thickness = 3/16"

Section properties:

$$A = 3.913 \text{ in}$$

$$I_{xx} = 3.913 \text{ in}^4$$

$$I_{yy} = 5.453 \text{ in}^4$$

$$S_x = 1.981 \text{ in}^3$$

$$S_y = 1.846 \text{ in}^3$$

$$F_t = 15 \text{ Ksi} \quad (\text{ADM, Table 2-24})$$

$$\text{Bracket bending capacity} = F_t \times S$$

$$= 15(\text{Ksi}) \times 1.981 (\text{in}^3)$$

$$= 29.7 \text{ kip.in}$$

$$= 2.475 \text{ kip.ft}$$

$$\text{Applied moment} = 1000 \text{ lb.ft} < \text{allowable capacity} \\ = 2475 \text{ lb.ft}$$

(OK)



PROJECT NO. _____ SHEET _____ OF _____
PROJECT NAME _____ DESIGNED BY _____ DATE _____
SUBJECT _____ CHECKED BY _____ DATE _____

Check Anchors - wood deck

Tension on 2 lag screws = 1920 lb

withdrawal capacity of $3/8"$ lag screw = 305 lb/in
(NDS, 11.2A)

$$\text{Embed. length} = \frac{1920 \text{ lb}}{305 \text{ lb/in}} = 6.29 \text{ in} / 2 \text{ bolts} = 3.14" / \text{bolt}$$

$$\text{shear} / \text{bolt} = \frac{441}{4} = 110.25 \text{ lb}$$

$3/8"$ ϕ lag screw shear capacity = 130 lb (NDS 12K)

total capacity of 4 bolts = $4 \times 130 = 520 \text{ lb} > 441 \text{ lb}$
(OK)

use [4 - $3/8"$ ϕ lag screws, w/4" min Embed]



PROJECT NO. _____ SHEET _____ OF _____
PROJECT NAME _____ DESIGNED BY _____ DATE _____
SUBJECT _____ CHECKED BY _____ DATE _____

Check anchors - Concrete deck

$$\text{Tension / 2 bolts} = 1920 \text{ lb}$$

$$\text{Tension / bolt} = \frac{1920}{2} = 960 \text{ lb}$$

$$\text{Shear / 4 bolts} = 441 \text{ lb} \quad (\text{RISA output})$$

$$\text{Shear / bolt} = \frac{441}{4} = 110.25 \text{ lb} \quad (\text{Negligible})$$

Concrete breakout strength

ACI 318-14

$$N_{cbg} = \frac{A_{NC}}{A_{NCO}} \cdot \psi_{ec,N} \cdot \psi_{ed,N} \cdot \psi_{c,N} \cdot \psi_{cp,N} \cdot N_b \quad (17-4.2.1-b)$$

$$A_{NC} = (C_{a1} + s_1 + 1.5 h_{ef}) * 2 * 1.5 h_{ef}$$

$$C_{a1} = 2.5$$

$$h_{ef} = 4 \text{ in}$$

$$s_1 = 4.5 \text{ in}$$



PROJECT NO. _____ SHEET _____ OF _____
 PROJECT NAME _____ DESIGNED BY _____ DATE _____
 SUBJECT _____ CHECKED BY _____ DATE _____

$$A_{NC} = (2.5 + 4.5 + 1.5 \times 4) \times 2 \times 1.5 \times 4 = 156$$

$$A_{NC0} = 9 h_{ef}^2 = 9 \times 4^2 = 144 \text{ in}^2$$

$$\psi_{e,c,N} = \frac{1}{1 + \frac{2e_N}{3h_{ef}}} = \frac{1}{1 + \frac{2 \times 4.5/2}{3 \times 4}} = 0.727$$

$$\psi_{e,d,N} = 0.7 + 0.3 \frac{C_a}{1.5 h_{ef}}$$

$$= 0.7 + 0.3 \times \frac{2.5}{1.5 \times 4} = 0.825$$

$$\psi_{c,N} = 1.4, \quad C_{CP,N} = 1.0$$

$$N_b = K_c \lambda_a \sqrt{f_c'} h_{ef}^{1.5} \quad (f_c' = 2500 \text{ psi})$$

$$= 17 \times 1 (2500)^{1/2} \cdot 4^{1.5} = 6800 \text{ lb}$$

$$N_{cbg} = \frac{156}{144} \times 0.727 \times 0.825 \times 1.4 \times 6800 = 6185 \text{ lb}$$

per ESR-2427, Table 3, $\frac{3}{8}$ " ϕ bolt ten. capacity
 = 4200 lb

so Tensile strength of 2 bolts = $2 \times 4200 = 8400 \text{ lb}$

Precision Structural Engineering, Inc.
250 Main Street, Suite A • Klamath Falls, OR 97601
Tel (541) 850-8300 • FAX (541) 850-6233

www.structure1.com • Email: info@structure1.com

Medford Office
836 Mason Way (off Sage Road) • Medford, OR 97501
Tel (541) 858-8500



PROJECT NO. _____ SHEET _____ OF _____
PROJECT NAME _____ DESIGNED BY _____ DATE _____
SUBJECT _____ CHECKED BY _____ DATE _____

Tension capacity = 8400^{lb} > Concrete breakout = 6701^{lb}
(bolts) "Concrete Controls"

o.o. Allowable Tension load = $0.65 \times \frac{61.85}{1.6} = 2512$ ^{lb}

o.o. Allowable Tension = 2512^{lb} > Applied Tension = 1920^{lb}
(OK)

USE [4 - $\frac{3}{8}$ " ϕ Red head ITW or LDT
w/min 4" Embed, $\frac{1}{2}$ 3" Edge distance
 $f'_c \nless 2500$ PSI]



PROJECT NO. _____ SHEET _____ OF _____
 PROJECT NAME _____ DESIGNED BY _____ DATE _____
 SUBJECT _____ CHECKED BY _____ DATE _____

Corner fascia bracket

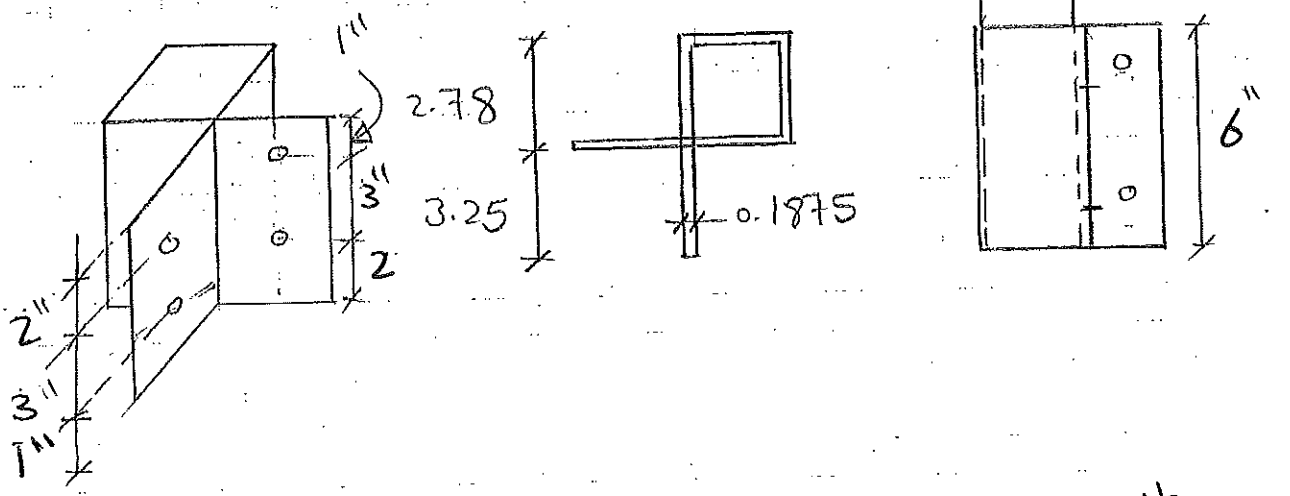

Bracket properties

$A = 3.28 \text{ in}^2$
 $I_x = I_y = 8.538 \text{ in}^4$
 $S_x = S_y = 2.067 \text{ in}^3$
 $F_t = 15 \text{ ksi}$

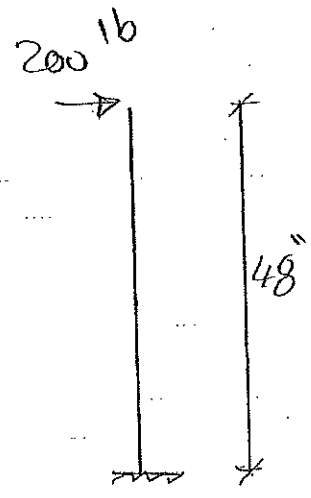

o.o Bracket bending capacity = $15 \text{ (ksi)} \times 2.067 \text{ (in}^3)$
 $= 31.0 \text{ Kip}\cdot\text{in} = 2583 \text{ lb}\cdot\text{ft}$

Max applied moment = $200 \times 4 \text{ lb}\cdot\text{ft} < 2583 \text{ lb}\cdot\text{ft}$
 $= 800$ (OK)

2012

Jun 30, 2017
13:29 PM
Checked By: _____

Company :
Designer :
Job Number :

Section Properties: Section1_1.dxf

Section Information:

Material Type	=	General
Shape Type	=	Arbitrary
Number of Shapes	=	1

Basic Properties:

Total Width	=	6.584	in
Total Height	=	6.584	in
Centroid, X _o	=	1.599	in
Centroid, Y _o	=	-2.033	in
X-Bar (Right)	=	4.129	in
X-Bar (Left)	=	2.455	in
Y-Bar (Top)	=	2.455	in
Y-Bar (Bot)	=	4.129	in
Max Thick	=	6.584	in

Equivalent Properties:

Area, A _x	=	3.283	in ²
Inertia, I _{xx}	=	8.534	in ⁴
Inertia, I _{yy}	=	8.534	in ⁴
Inertia, I _{xy}	=	-4.405	in ⁴
S _x (Top)	=	3.476	in ³
S _x (Bot)	=	2.067	in ³
S _y (Left)	=	3.476	in ³
S _y (Right)	=	2.067	in ³
r _x	=	1.612	in
r _y	=	1.612	in
Plastic Z _x	=	4.101	in ³
Plastic Z _y	=	4.098	in ³
Torsional J	=	3.341	in ⁴
As-xx Def	=	1.000	
As-yy Def	=	1.000	
As-xx Stress	=	1.000	
As-yy Stress	=	1.000	

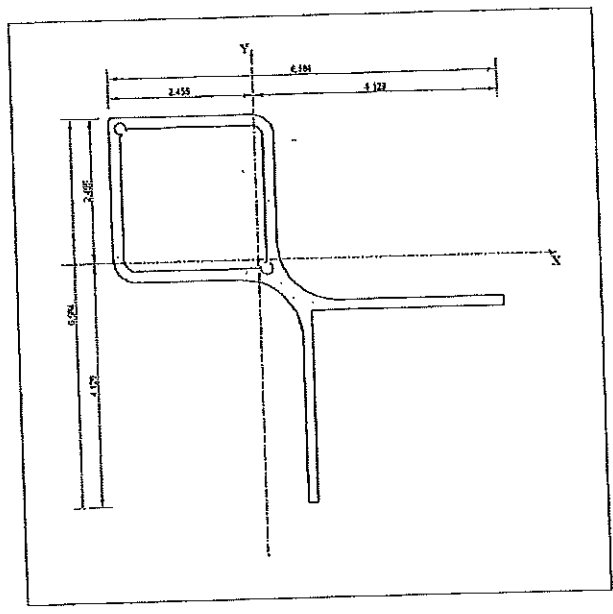

Section Diagram

2013

Company :
Designer :
Job Number :

Jun 30, 2017
13:29 PM
Checked By: _____

Summary of Section Properties

Section Information:

Sn.No.	1
Section	Section1_1...

Basic Properties:

Total Width (in)	6.584
Total Height (in)	6.584
Centroid, X _o (in)	1.599
Centroid, Y _o (in)	-2.033
X-Bar (Right) (in)	4.129
X-Bar (Left) (in)	2.455
Y-Bar (Top) (in)	2.455
Y-Bar (Bot) (in)	4.129

Equivalent Properties:

Area, A _x (in ²)	3.283
Inertia, I _{xx} (in ⁴)	8.534
Inertia, I _{yy} (in ⁴)	8.534
Inertia, I _{xy} (in ⁴)	-4.405
S _x (Top) (in ³)	3.476
S _x (Bot) (in ³)	2.067
S _y (Left) (in ³)	3.476
S _y (Right) (in ³)	2.067
r _x (in)	1.612
r _y (in)	1.612
Plastic Z _x (in ³)	4.101
Plastic Z _y (in ³)	4.098
Torsional J (in ⁴)	3.341

PSE Consulting Engineers, Inc.
250 Main St. Suite A
Klamath Falls, OR 97601
P: 541-850-6300 F: 541-850-6233
www.structure1.com

2nd office Location
836 Mason Way
Medford, OR 97501
P: 541-858-8500 F: 541-776-463
Email: info@structure1.com

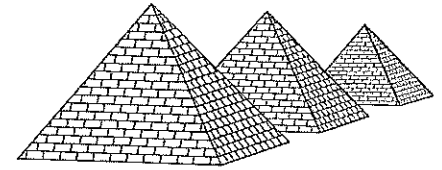

Project No: Eglass 217-2
Project Name: _____
Subject: _____

SHEET # _____ OF _____
DESIGNED BY _____ DATE _____
CHECKED BY _____ DATE _____

check anchor - wood deck

$$\text{Max moment} = 800 \text{ lb. ft}$$

50% of moment will be resisted by shear in 2 bolts

and 50% will be resisted by tension in the other 2 bolts

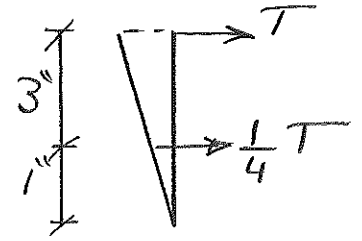

check for Tension

$$\frac{1}{2} \text{ Moment} = 4T + \frac{1}{4}T$$

$$\frac{1}{2} * 800 * 12 \frac{\text{in}}{\text{ft}} = 4.25T$$

$$T = 1,129 \text{ lb}$$

$$\frac{3}{8} \text{ } \varnothing \text{ lag screw withdrawal capacity} = 305 \text{ lb}$$

$$\text{Embed length} = \frac{1129 \text{ lb}}{305 * 1.6} = 2.3''$$

G_c factor \uparrow

PSE Consulting Engineers, Inc.
250 Main St. Suite A
Klamath Falls, OR 97601
P: 541-850-6300 F: 541-850-6233
www.structure1.com

2nd office Location
836 Mason Way
Medford, OR 97501
P: 541-858-8500 F: 541-776-463
Email: info@structure1.com

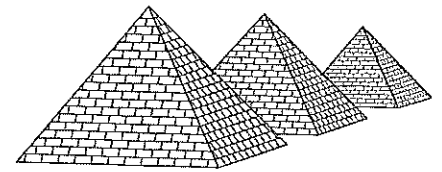

Project No: Egla88 217-2
Project Name: _____
Subject: _____

SHEET # _____ OF _____
DESIGNED BY AF DATE _____
CHECKED BY _____ DATE _____

check for shear

$\frac{1}{2}$ " lag screw shear capacity = 520^{lb}

$\frac{1}{2}$ Moment = 13" δ δ = shear

$$\frac{1}{2} * 800 (16 ft) * 12 = 13" \delta$$

$$\delta = 1,600 \text{ lb}$$

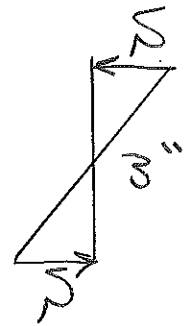

$$\# \text{ screw } \delta = \frac{1600}{520 * 1.6} = 1.92$$

use $\left[\begin{array}{l} 4 - \frac{1}{2} \text{ } \phi \text{ lag screw w/ 4" min. Embed} \\ 2 \text{ screws each side} \end{array} \right]$



PROJECT NO. _____ SHEET _____ OF _____
 PROJECT NAME _____ DESIGNED BY _____ DATE _____
 SUBJECT _____ CHECKED BY _____ DATE _____

check anchor - Concrete deck

Single bolt in tension, Max Tension = 1600 lb

$$N_{cb} = \frac{A_{NC}}{A_{NCO}} \cdot \psi_{ed,N} \cdot \psi_{c,N} \cdot \psi_{cp,N} \cdot N_b$$

(17.4.2.1-a)

$$A_{NC} = (C_{a1} + 1.5 \text{ hef}) \times 2 \times 1.5 \text{ hef}$$

$$= (1.5 + 1.5 \times 4) \times 2 \times 1.5 \times 3 = 54 \text{ in}^2$$

$$A_{NCO} = 9 \text{ hef}^2 = 9 \times 3^2 = 81 \text{ in}^2$$

$$N_b = 17 \sqrt{2800} \times \frac{1.5}{3} = 4416 \text{ lb}$$

$$\psi_{ed,N} = 0.7 + 0.3 \times \frac{1.5}{1.5 \times 3} = 0.8$$

$$\psi_{c,N} = 1.4$$

$$\psi_{cp,N} = 1.0$$

$$N_{cb} = \frac{54}{81} \times 0.8 \times 1.4 \times 1.0 \times 4416 = 3297 \text{ lb} < 8925 \text{ lb}$$

$\frac{1}{2}$ " ϕ bolt tensile strength \uparrow

o.o. Concrete breakout controls

$\frac{1}{2}$ of Tension
 will be shown
 on the other
 2 bolts
 % Tension = $\frac{1600}{2}$
 = 800 lb

Precision Structural Engineering, Inc.
250 Main Street, Suite A • Klamath Falls, OR 97601
Tel (541) 850-8300 • FAX (541) 850-6233

www.structure1.com • Email: Info@structure1.com

Medford Office
836 Mason Way (off Sage Road) • Medford, OR 97501
Tel (541) 858-8500



PROJECT NO. _____ SHEET _____ OF _____
PROJECT NAME _____ DESIGNED BY _____ DATE _____
SUBJECT _____ CHECKED BY _____ DATE _____

$$0.0 \text{ Allowable tensile strength} = 0.65 \times \frac{3297}{1.6} = 1339 \text{ lb}$$

> applied tension
= 800 lb (OK)

USE $4 - \frac{1}{2} \phi$ Red head ITW or LDT
w/ min 3" Embed, 1.5" edge dist.
 $f'_c \geq 2500$ psi

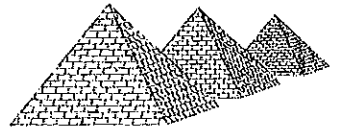

PROJECT NO. _____ SHEET _____ OF _____
PROJECT NAME _____ DESIGNED BY _____ DATE _____
SUBJECT _____ CHECKED BY _____ DATE _____

135° post, 42" post, Deck mount

Section properties

$$A = 0.931 \text{ in}^2$$

$$J = 1.442 \text{ in}^4$$

$$I_x = 0.851 \text{ in}^4$$

$$I_y = 1.038 \text{ in}^4$$

$$S_x = 0.579 \text{ in}^3$$

$$S_y = 0.596 \text{ in}^3$$

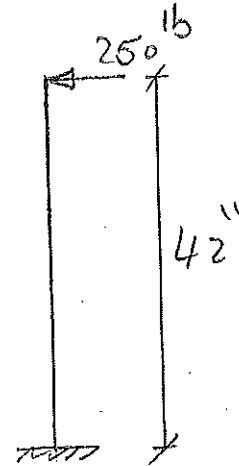

$$M = 250 \text{ lb} \times \frac{42 \text{ in}}{12} = 875 \text{ lb-ft}$$

Equivalent section

RT 1.75 * 2.5 * 0.125

AS per RISA model, post is safe

2018

Jun 30, 2017
 13:24 PM
 Checked By: _____

Company :
 Designer :
 Job Number :

Section Properties: Section1_1.dxf

Section Information:

Material Type	=	Hot Rolled Steel
Shape Type	=	Pipe
Number of Shapes	=	1

Basic Properties:

Total Width	=	3.465	in
Total Height	=	2.912	in
Centroid, X _o	=	0.000	in
Centroid, Y _o	=	-0.034	in
Shear Center, X _s	=	0.000	in
Shear Center, Y _s	=	0.000	in
X-Bar (Right)	=	1.732	in
X-Bar (Left)	=	1.732	in
Y-Bar (Top)	=	1.441	in
Y-Bar (Bot)	=	1.471	in
Thickness	=	0.102	in

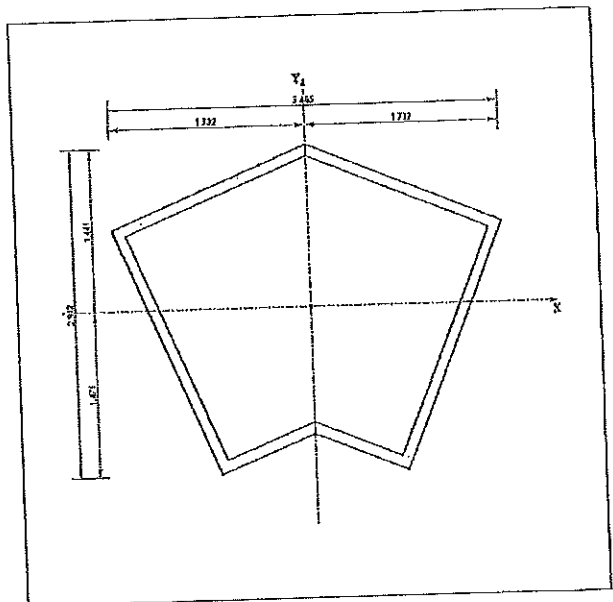

Section Diagram

Equivalent Properties:

Area, A _x	=	0.931	in ²
Inertia, I _{xx}	=	0.851	in ⁴
Inertia, I _{yy}	=	1.033	in ⁴
Inertia, I _{xy}	=	0.000	in ⁴
S _x (Top)	=	0.591	in ³
S _x (Bot)	=	0.579	in ³
S _y (Left)	=	0.596	in ³
S _y (Right)	=	0.596	in ³
r _x	=	0.956	in
r _y	=	1.053	in
Plastic Z _x	=	0.808	in ³
Plastic Z _y	=	0.879	in ³
Torsional J	=	1.442	in ⁴

2019

Company :
Designer :
Job Number :

Jun 30, 2017
13:24 PM
Checked By: _____

Summary of Section Properties

Section Information:

Sn.No. 1
Section Section1_1...

Basic Properties:

Total Width (in) 3.465
Total Height (in) 2.912
Centroid, Xo (in) 0.000
Centroid, Yo (in) -0.034
X-Bar (Right) (in) 1.732
X-Bar (Left) (in) 1.732
Y-Bar (Top) (in) 1.441
Y-Bar (Bot) (in) 1.471

Equivalent Properties:

Area, Ax (in²) 0.931
Inertia, Ixx (in⁴) 0.851
Inertia, Iyy (in⁴) 1.033
Inertia, Ixy (in⁴) 0.000
Sx (Top) (in³) 0.591
Sx (Bot) (in³) 0.579
Sy (Left) (in³) 0.596
Sy (Right) (in³) 0.596
rx (in) 0.956
ry (in) 1.053
Plastic Zx (in³) 0.808
Plastic Zy (in³) 0.879
Torsional J (in⁴) 1.442

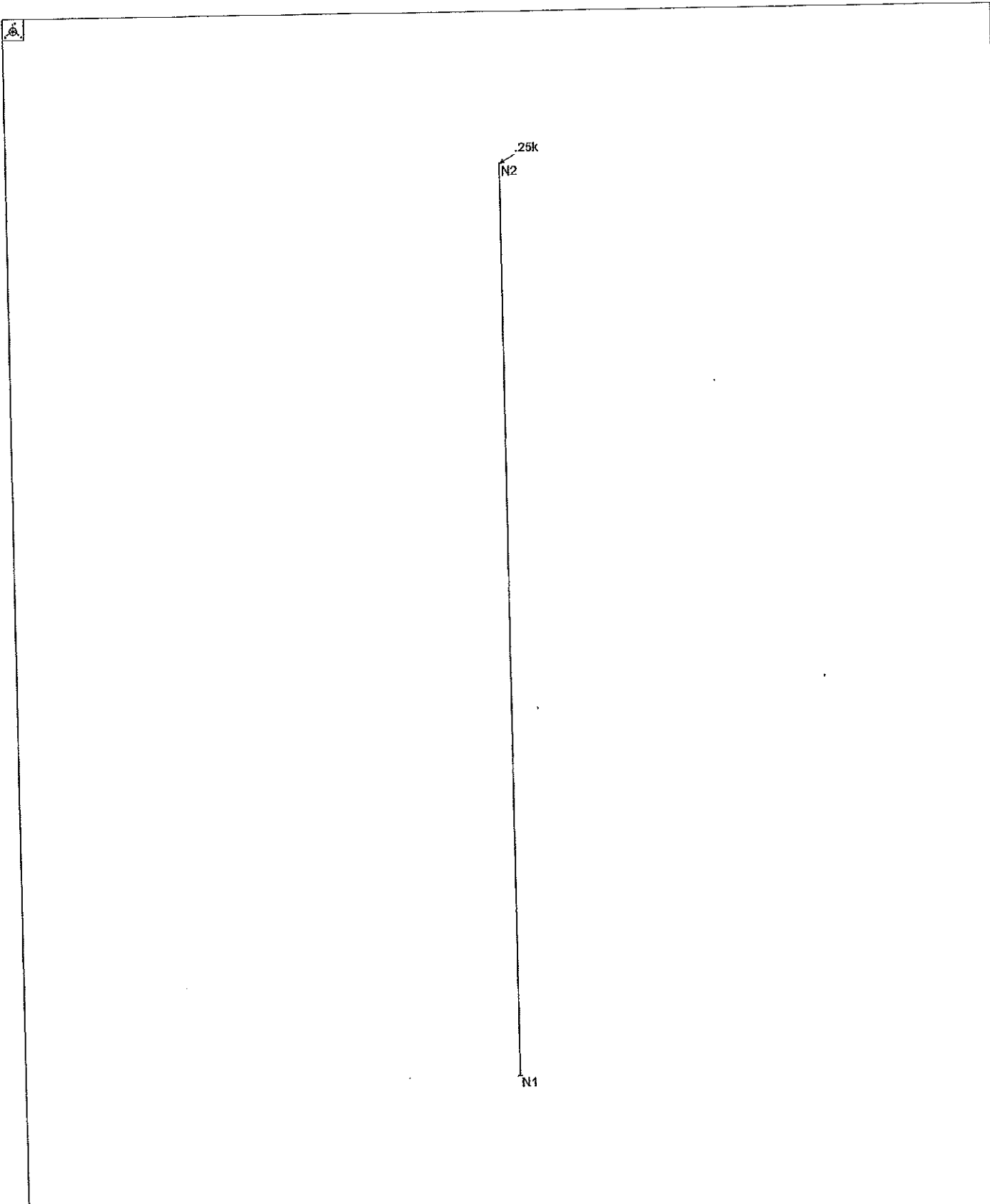

Loads: BLC 1, dl
Envelope Only Solution

PSE	42" tall - 135 degree post	SK - 1
AF		Aug 29, 2017 at 3:33 PM
Eglass 217-2		135 post.r3d



Company : PSE
 Designer : AF
 Job Number : Eglass 217-2
 Model Name : 42" tall - 135 degree post

Aug 29, 2017
 3:34 PM
 Checked By: NT

Aluminum Properties

	Label	E [ksi]	G [ksi]	Nu	Therm (...)	Density [lb/in3]	Table B.4	kt	Ftu [ksi]	Fty [ksi]	Fcy [ksi]	Fsu [ksi]	Ct
1	3003-H14	10100	3787.5	33	1.3	.173	Table B.4-1	1	19	16	13	12	141
2	6061-T6	10100	3787.5	33	1.3	.173	Table B.4-2	1	38	35	35	24	141
3	6063-T5	10100	3787.5	33	1.3	.173	Table B.4-2	1	22	16	16	13	141
4	6063-T6	10100	3787.5	33	1.3	.173	Table B.4-2	1	30	25	25	19	141
5	5052-H34	10200	3787.5	33	1.3	.173	Table B.4-1	1	34	26	24	20	141
6	6061-T6 W	10100	3787.5	33	1.3	.173	Table B.4-1	1	24	15	15	15	141

Aluminum Section Sets

	Label	Shape	Type	Design List	Material	Design Rules	A [in2]	Iyy [in4]	Izz [in4]	J [in4]
1	AL1A	RT1.75X2.5X0..	Column	Rectangular Tubes	6061-T6	Typical	1	.484	.855	.931

Aluminum Design Parameters

	Label	Shape	Length [ft]	Lbyy [ft]	Lbzz [ft]	Lcomp top [ft]	Lcomp bot [ft]	L-torqu...	Kyy	Kzz	Cb	Function
1	M1	AL1A	3.5			Lbyy						Lateral

Joint Coordinates and Temperatures

	Label	X [ft]	Y [ft]	Z [ft]	Temp [F]	Detach From Diap...
1	N1	0	0	0	0	
2	N2	0	3.5	0	0	

Joint Boundary Conditions

	Joint Label	X [k/in]	Y [k/in]	Z [k/in]	X Rot. [k-ft/rad]	Y Rot. [k-ft/rad]	Z Rot. [k-ft/rad]
1	N1	Reaction	Reaction	Reaction	Reaction	Reaction	Reaction

Joint Loads and Enforced Displacements (BLC 1 : dl)

	Joint Label	L,D,M	Direction	Magnitude [(k,k-ft), (in,rad), (k*s^2/ft...)]
1	N2	L	Z	.25

Basic Load Cases

	BLC Description	Category	X Gravity	Y Gravity	Z Gravity	Joint	Point	Distribut.	Area (M...	Surface...
1	dl	DL		-1		1				

Load Combinations

	Description	Sol...	PDelta	SR...	BLC Fact...	BLC Fact...	BLC Fact...	BLC Fact...	BLC Fact...	BLC Fact...	BLC Fact...	BLC Fact...
1	Yes	Y		1	1							

Envelope AA ADM1-10: ASD - Building Aluminum Code Checks

	Member	Shape	Code C...	Loc [ft]	LC Shear ...	Loc [ft]	Dir	LC Pnc/O...	Pn/Om...	Mny/O...	Mnz/O...	Vny/O...	Vnz/O...	Cb	Eqn
1	M1	RT1.75X...	.895	0	1	.057	0	z	1	12.636	19.487	.978	1.209	6.761	4.375 1 H.1-1



PROJECT NO. _____ SHEET _____ OF _____
PROJECT NAME _____ DESIGNED BY _____ DATE _____
SUBJECT _____ CHECKED BY _____ DATE _____

135° post base plate

Assume $t = 0.39$ in

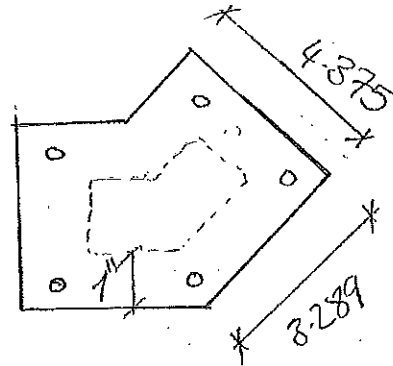

$$t \geq e \sqrt{\frac{2P_u}{0.9A_f y}}, \quad e = 1''$$

$$A = 20.85 \text{ in}^2, \quad F_y = 28 \text{ Ksi}$$

$$P_u = 441 \text{ lb} \times 1.5 = 661.5 \text{ lb}$$

$$t \geq \sqrt{\frac{2 \times 661.5}{28,000 \times 0.9 \times 20.85}} = 0.05 \text{ in}$$

Use $[0.39'' \times \text{shape as shown, Aluminium}]$



PROJECT NO. _____ SHEET _____ OF _____
PROJECT NAME _____ DESIGNED BY _____ DATE _____
SUBJECT _____ CHECKED BY _____ DATE _____

Anchors

Tension on one anchor = $\frac{M}{d} = T$
(Anchor @ middle)

d = distance between anchor & base plate
farther edge = 4.2 in

$$M = T \cdot d$$

$$= 4.2T + 3.77 * \frac{3.77}{4.2} T + \frac{0.65 * 0.65}{4.2} T$$

$$= 7.7T$$

$$M = 1000 \text{ lb}\cdot\text{ft}$$

$$1000 = \frac{7.7 * T}{12} \Rightarrow T = 1561 \text{ lb}$$



PROJECT NO. Eg/285 217-1 SHEET 2022 OF _____
PROJECT NAME _____ DESIGNED BY AF DATE _____
SUBJECT _____ CHECKED BY _____ DATE _____

Anchors with Concrete

$$N_{cb} = \frac{A_{NC}}{A_{NCO}} \psi_{ed,N} \cdot \psi_{c,N} \cdot \psi_{cp,N} \cdot N_b$$

$$A_{NC} = (3 + 1.5 \times 3) \times (2 \times 1.5 \times 3) = 67.5 \text{ in}^2$$

$$A_{NCO} = 9 \times 3^2 = 81 \text{ in}^2$$

$$N_b = 17 \sqrt{2500} \times 3^{-1.5} = 4,416 \text{ lb}$$

$$\psi_{ed} = 0.7 + 0.3 \frac{3}{1.5 \times 3} = 0.9$$

$$\psi_{c,N} = 1.4$$

$$\psi_{cp,N} = 1.0$$

$$N_{cb} = \frac{67.5}{81} \times 0.9 \times 1.4 \times 1 \times 4416 = 4686 \text{ lb}$$

$$\frac{3}{8} \text{ } \phi \text{ bolt tension capacity} = 4200 \text{ lb} < 4686 \text{ lb}$$

∴ bolt capacity controls

$$\text{Allowable Ten. load} = 0.65 \times \frac{4200}{1.6} = 1575 \text{ lb}$$

$$\frac{\text{Applied Tension}}{\text{allowable tension}} = \frac{1561}{1575} = 0.99$$



PROJECT NO. Eg1285 217-1 SHEET 2023 OF _____
PROJECT NAME _____ DESIGNED BY AF DATE _____
SUBJECT _____ CHECKED BY _____ DATE _____

* check for shear

$$V_{cb} = \frac{A_{vc}}{A_{vco}} \cdot \psi_{ed,v} \cdot \psi_{cn} \cdot \psi_{hv} \cdot V_b$$

$$A_{vc} = 1.5 \times 3 \times (1.5 \times 3 + 3) = 38.75 \text{ in}^2$$

$$A_{vco} = 4.5 \times 3^2 = 40.5 \text{ in}^2$$

$$V_b = 7 \times \left(\left(\frac{3}{318} \right)^{0.2} \sqrt{318} \right) \times \sqrt{2500 \times 3^{-1.5}} = 1688 \text{ lb}$$

$$\psi_{ed,v} = 1.0$$

$$\psi_{cn} = 1.4$$

$$\psi_{hv} = \sqrt{\frac{1.5 \times 3}{8}} = 1.22$$

$$V_{cb} = \frac{38.75}{40.5} \times 1 \times 1.4 \times 1.22 \times 1688 = 2402 \text{ lb}$$

$\frac{3}{8}$ " ϕ bolt shear capacity = 1830^{lb} (controls)

$$\text{Allowable shear} = 0.7 \times \frac{1830}{1.6} = 800 \text{ lb}$$

$$\text{shear/bolt} = \frac{400}{5} = 80 \text{ lb}$$

$$\frac{\text{Applied shear}}{\text{Allowable shear}} = \frac{80}{800} = 0.1 < 0.2$$

Precision Structural Engineering, Inc.
250 Main Street, Suite A • Klamath Falls, OR 97601
Tel (541) 850-6300 • FAX (541) 850-6233

Medford Office
836 Mason Way (off Sage Road) • Medford, OR 97501
Tel (541) 858-8500

www.structure1.com • Email: info@structure1.com



PROJECT NO. Egls 217-1 SHEET 2024 OF _____
PROJECT NAME _____ DESIGNED BY AF DATE _____
SUBJECT _____ CHECKED BY _____ DATE _____

∞ ∞ Interaction of shear & Tension won't reduce allowable Tension load

∞ ∞

use = [5 - $\frac{3}{8}$ " ϕ Rod head ITW or LDT
w/min 4" Embed $\frac{1}{4}$ " ϕ edge distance
 $f_c' < 2500$ psi]

Precision Structural Engineering, Inc.
250 Main Street, Suite A • Klamath Falls, OR 97601
Tel (541) 850-8300 • FAX (541) 850-8233

Medford Office
836 Mason Way (off Sage Road) • Medford, OR 97501
Tel (541) 858-8500

www.structure1.com • Email: info@structure1.com



PROJECT NO. Egless 217-1 SHEET 2025 OF _____
PROJECT NAME _____ DESIGNED BY AF DATE _____
SUBJECT _____ CHECKED BY _____ DATE _____

Anchors with wood

$\frac{1}{2}$ " ϕ lag screw withdrawal capacity = 302 lb

Embed length = $\frac{1561 \text{ lb}}{302 \times 1.6} = 3.2 \text{ in}$

use = [5 - $\frac{1}{2}$ " ϕ lag screw w/ 4" min Embed]

Table 2.3.2 Frequently Used Load Duration Factors, C_D ¹

Load Duration	C_D	Typical Design Loads
Permanent	0.9	Dead Load
Ten years	1.0	Occupancy Live Load
Two months	1.15	Snow Load
Seven days	1.25	Construction Load
Ten minutes	1.6	Wind/Earthquake Load
Impact ²	2.0	Impact Load

1. Load duration factors shall not apply to reference modulus of elasticity, E , reference modulus of elasticity for beam and column stability, E_{min} , nor to reference compression perpendicular to grain design values, F_{cL} , based on a deformation limit.
2. Load duration factors greater than 1.6 shall not apply to structural members pressure-treated with water-borne preservatives (see Reference 30), or fire retardant chemicals. The impact load duration factor shall not apply to connections.

2.3.3 Temperature Factor, C_t

Reference design values shall be multiplied by the temperature factors, C_t , in Table 2.3.3 for structural members that will experience sustained exposure to elevated temperatures up to 150°F (see Appendix C).

2.3.4 Fire Retardant Treatment

The effects of fire retardant chemical treatment on strength shall be accounted for in the design. Adjusted design values, including adjusted connection design values, for lumber and structural glued laminated timber pressure-treated with fire retardant chemicals shall be obtained from the company providing the treatment and redrying service. Load duration factors greater than 1.6 shall not apply to structural members pressure-treated with fire retardant chemicals (see Table 2.3.2).

2.3.5 Format Conversion Factor, K_F (LRFD Only)

For LRFD, reference design values shall be multiplied by the format conversion factor, K_F , specified in Table 2.3.5. The format conversion factor, K_F , shall not apply for designs in accordance with ASD methods specified herein.

2.3.6 Resistance Factor, ϕ (LRFD Only)

For LRFD, reference design values shall be multiplied by the resistance factor, ϕ , specified in Table 2.3.6. The resistance factor, ϕ , shall not apply for designs in accordance with ASD methods specified herein.

2.3.7 Time Effect Factor, λ (LRFD Only)

For LRFD, reference design values shall be multiplied by the time effect factor, λ , specified in Appendix N.3.3. The time effect factor, λ , shall not apply for designs in accordance with ASD methods specified herein.

Table 2.3.3 Temperature Factor, C_t

Reference Design Values	In-Service Moisture Conditions ¹	C_t		
		$T \leq 100^\circ\text{F}$	$100^\circ\text{F} < T \leq 125^\circ\text{F}$	$125^\circ\text{F} < T \leq 150^\circ\text{F}$
F_b, E, E_{min}	Wet or Dry	1.0	0.9	0.9
$F_b, F_v, F_c,$ and F_{cL}	Dry	1.0	0.8	0.7
	Wet	1.0	0.7	0.5

1. Wet and dry service conditions for sawn lumber, structural glued laminated timber, prefabricated wood I-joists, structural composite lumber, wood structural panels and cross-laminated timber are specified in 4.1.4, 5.1.4, 7.1.4, 8.1.4, 9.3.3, and 10.1.5 respectively.

Table 12.2A Lag Screw Reference Withdrawal Design Values, W¹

Tabulated withdrawal design values (W) are in pounds per inch of thread penetration into side grain of wood member. Length of thread penetration in main member shall not include the length of the tapered tip (see 12.2.1.1).

Specific Gravity, G ²	Lag Screw Diameter, D										
	1/4"	5/16"	3/8"	7/16"	1/2"	5/8"	3/4"	7/8"	1"	1-1/8"	1-1/4"
0.73	397	469	538	604	668	789	905	1016	1123	1226	1327
0.71	381	450	516	579	640	757	868	974	1077	1176	1273
0.68	357	422	484	543	600	709	813	913	1009	1103	1193
0.67	349	413	473	531	587	694	796	893	987	1078	1167
0.58	281	332	381	428	473	559	641	719	795	869	940
0.55	260	307	352	395	437	516	592	664	734	802	868
0.51	232	274	314	353	390	461	528	593	656	716	775
0.50	225	266	305	342	378	447	513	576	636	695	752
0.49	218	258	296	332	367	434	498	559	617	674	730
0.47	205	242	278	312	345	408	467	525	580	634	686
0.46	199	235	269	302	334	395	453	508	562	613	664
0.44	186	220	252	283	312	369	423	475	525	574	621
0.43	179	212	243	273	302	357	409	459	508	554	600
0.42	173	205	235	264	291	344	395	443	490	535	579
0.41	167	198	226	254	281	332	381	428	473	516	559
0.40	161	190	218	245	271	320	367	412	455	497	538
0.39	155	183	210	236	261	308	353	397	438	479	518
0.38	149	176	202	227	251	296	340	381	422	461	498
0.37	143	169	194	218	241	285	326	367	405	443	479
0.36	137	163	186	209	231	273	313	352	389	425	460
0.35	132	156	179	200	222	262	300	337	373	407	441
0.31	110	130	149	167	185	218	250	281	311	339	367

1. Tabulated withdrawal design values, W, for lag screw connections shall be multiplied by all applicable adjustment factors (see Table 11.3.1).
2. Specific gravity, G, shall be determined in accordance with Table 12.3.3A.

12.2.3.2 For calculation of the fastener reference withdrawal design value in pounds, the unit reference withdrawal design value in lbs/in. of fastener penetration from 12.2.3.1 shall be multiplied by the length of fastener penetration, p_b, into the wood member.

12.2.3.3 The reference withdrawal design value, in lbs/in. of penetration, for a single post-frame ring shank nail driven in the side grain of the main member, with the nail axis perpendicular to the wood fibers, shall be determined from Table 12.2D or Equation 12.2-4, within the range of specific gravities and nail diameters given in Table 12.2D. Reference withdrawal design values, W, shall be multiplied by all applicable adjustment factors (see Table 11.3.1) to obtain adjusted withdrawal design values, W¹.

$$W = 1800 G^2 D \quad (12.2-4)$$

12.2.3.4 For calculation of the fastener reference withdrawal design value in pounds, the unit reference withdrawal design value in lbs/in. of ring shank penetration from 12.2.3.3 shall be multiplied by the length of ring shank penetration, p_r, into the wood member.

12.2.3.5 Nails and spikes shall not be loaded in withdrawal from end grain of wood (C_{eg}=0.0).

12.2.3.6 Nails, and spikes shall not be loaded in withdrawal from end-grain of laminations in cross-laminated timber (C_{eg}=0.0).

12.2.4 Drift Bolts and Drift Pins

Reference withdrawal design values, W, for connections using drift bolt and drift pin connections shall be determined in accordance with 11.1.1.3.

Table 12K LAG SCREWS: Reference Lateral Design Values, Z, for Single Shear

(two member) Connections^{1,2,3,4}

for sawn lumber or SCL with ASTM A653, Grade 33 steel side plate (for $t_s < 1/4"$) or ASTM A 36 steel side plate (for $t_s = 1/4"$)

(tabulated lateral design values are calculated based on an assumed length of lag screw penetration, p, into the main member equal to 8D)



Side Member Thickness t_s in.	Lag Screw Diameter D in.	G=0.67 Red Oak		G=0.55 Mixed Maple Southern Pine		G=0.5 Douglas Fir-Larch		G=0.49 Douglas Fir-Larch (N)		G=0.46 Douglas Fir(S) Hem-Fir(N)		G=0.43 Hem-Fir		G=0.42 Spruce-Pine-Fir		G=0.37 Redwood (open grain)		G=0.36 Eastern Softwoods Spruce-Pine-Fir(S) Western Cedars Western Woods		G=0.35 Northern Species	
		Z_{II} lbs.	Z_{I} lbs.	Z_{II} lbs.	Z_{I} lbs.	Z_{II} lbs.	Z_{I} lbs.	Z_{II} lbs.	Z_{I} lbs.	Z_{II} lbs.	Z_{I} lbs.	Z_{II} lbs.	Z_{I} lbs.	Z_{II} lbs.	Z_{I} lbs.	Z_{II} lbs.	Z_{I} lbs.	Z_{II} lbs.	Z_{I} lbs.	Z_{II} lbs.	Z_{I} lbs.
0.075 (14 gage)	1/4	170	130	160	120	150	110	150	110	150	100	140	100	140	100	130	90	130	90	130	90
	5/16	220	160	200	140	190	130	190	130	190	130	180	120	180	120	170	110	170	110	160	100
	3/8	220	160	200	140	190	130	190	130	190	120	180	120	180	120	170	110	170	100	170	100
0.105 (12 gage)	1/4	180	140	170	130	160	120	160	120	160	110	150	110	150	110	140	100	140	100	140	90
	5/16	230	170	210	150	200	140	200	140	190	130	190	130	190	120	180	110	170	110	170	110
	3/8	230	160	210	140	200	140	200	130	200	130	190	120	190	120	180	110	180	110	170	110
0.120 (11 gage)	1/4	190	150	180	130	170	120	170	120	160	120	160	110	160	110	150	100	150	100	140	100
	5/16	230	170	210	150	210	140	200	140	200	140	190	130	190	130	180	120	180	120	180	110
	3/8	240	170	220	150	210	140	210	140	200	130	200	130	190	120	180	110	180	110	180	110
0.134 (10 gage)	1/4	200	150	180	140	180	130	170	130	170	120	160	120	160	110	150	110	150	100	150	100
	5/16	240	180	220	160	210	150	210	140	200	140	200	130	200	130	190	120	180	120	180	120
	3/8	240	170	220	150	220	140	210	140	210	140	200	130	200	130	190	120	190	120	180	110
0.179 (7 gage)	1/4	220	170	210	150	200	150	200	140	190	140	190	130	190	130	180	120	180	120	200	130
	5/16	260	190	240	170	230	160	230	160	230	150	220	150	220	150	210	130	200	130	200	130
	3/8	270	190	250	170	240	160	240	160	230	150	220	140	220	140	210	130	210	130	200	130
0.239 (3 gage)	1/4	240	180	220	160	210	150	210	150	200	140	190	140	190	130	180	120	180	120	180	120
	5/16	300	220	280	190	270	180	260	180	260	170	250	160	250	160	230	150	230	150	230	140
	3/8	310	220	280	190	270	180	270	180	260	170	250	160	250	160	240	140	230	140	230	140
	7/16	420	290	390	280	380	240	370	240	360	230	350	220	350	220	330	200	330	200	320	190
	1/2	510	340	470	300	460	290	450	280	440	270	430	260	420	260	400	240	400	230	390	230
	5/8	770	490	710	430	680	400	660	400	660	380	640	370	630	360	600	330	590	330	580	320
	3/4	1110	670	1020	590	980	560	970	550	950	530	920	500	910	500	860	450	850	450	840	440
	7/8	1510	880	1390	780	1330	730	1320	710	1280	690	1250	650	1230	650	1170	590	1160	590	1140	570
	1	1940	1100	1780	960	1710	910	1700	890	1650	860	1600	820	1590	810	1500	740	1480	730	1460	710
	1/4	1/4	240	180	220	160	210	150	210	150	200	140	200	140	190	130	180	120	180	120	180
5/16		310	220	280	200	270	180	270	180	260	170	250	170	250	160	230	150	230	150	230	140
3/8		320	220	290	190	280	180	270	180	270	170	260	160	250	160	240	150	240	140	230	140
7/16		480	320	440	280	420	270	420	260	410	250	390	240	390	230	370	220	360	210	360	210
1/2		580	390	540	340	520	320	510	320	500	310	480	290	480	290	460	270	450	260	440	260
5/8		850	530	780	470	750	440	740	440	720	420	700	400	690	400	660	370	650	360	640	350
3/4		1200	730	1100	640	1060	600	1050	590	1020	570	990	540	980	530	930	490	920	480	900	470
7/8		1600	930	1470	820	1410	770	1400	750	1360	720	1320	690	1310	680	1240	630	1220	620	1200	600
1	2040	1150	1870	1000	1800	950	1780	930	1730	900	1680	850	1660	840	1570	770	1550	760	1530	740	

1. Tabulated lateral design values, Z, shall be multiplied by all applicable adjustment factors (see Table 11.3.1).
2. Tabulated lateral design values, Z, are for "reduced body diameter" lag screws (see Appendix Table L2) inserted in side grain with screw axis perpendicular to wood fibers; screw penetration, p, into the main member equal to 8D; dowel bearing strengths, F_{db} , of 61,850 psi for ASTM A653, Grade 33 steel and 87,000 psi for ASTM A36 steel and screw bending yield strengths, F_{yb} , of 70,000 psi for $D = 1/4"$, 60,000 psi for $D = 5/16"$, and 45,000 psi for $D \geq 3/8"$.
3. Where the lag screw penetration, p, is less than 8D but not less than 4D, tabulated lateral design values, Z, shall be multiplied by $p/8D$ or lateral design values shall be calculated using the provisions of 12.3 for the reduced penetration.
4. The length of lag screw penetration, p, not including the length of the tapered tip, E (see Appendix Table L2), of the lag screw into the main member shall not be less than 4D. See 12.1.4.6 for minimum length of penetration, p_{min} .